

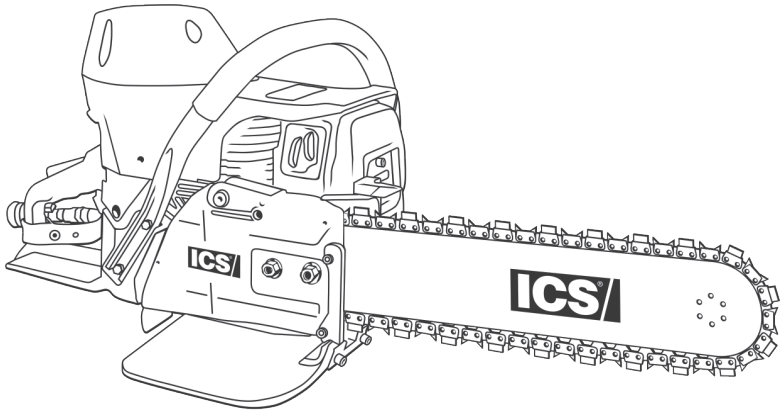

Diamond Tools and Equipment  
for Construction and Infrastructure

# 680ES



# SERVICE MANUAL

<b>SECTION</b>	<b>SECTION TITLE</b>	<b>PAGE NUMBER</b>
	SERVICE MANUAL USE	3
1	TOOLS	5
2	POWER CUTTER SPECIFICATIONS	6
3	SERIAL NUMBER LOCATION	7
4	SPARE PARTS DIAGRAM	8
5	AIR INTAKE	21
6	SPARK PLUG	22
7	CLUTCH & RIM SPROCKET	24
8	STARTER SYSTEM	28
9	WALLWALKER®	33
10	CYLINDER COVER	35
11	MUFFLER	38
12	CARBURETOR	40
13	CYLINDER & PISTON	42
14	WATER HOSE & CAP	51
15	IGNITION COIL	53
16	FLYWHEEL	55
17	BOTTOM GUARD	57
18	FRONT HANDLE	58
19	FUEL TANK	59
20	CRANKCASE	61
21	BAR STUDS & BAR PAD	68
22	CHAIN TENSIONER	69
23	CARBURETOR TUNING	70
24	IDLE SPEED ADJUSTMENT	73
25	DIAGRAMS	74
26	FUEL SYSTEM LEAKS	76
27	CRANKCASE LEAKS	78
	SPARK PLUG REFERENCE GUIDE	79

## Service Manual Use

This manual contains all the technical information necessary for carrying out repairs on the 680ES power cutter. For safe, efficient work, it is of prime importance that the values indicated be adhered to. Routine periodic maintenance is covered in the operator's manual included with each power cutter.

### General Shop Rules

- Always use the right tools for the job, otherwise components may be damaged.
- Use a plastic dead blow mallet to separate parts attached solidly to each other.
- Mark mating parts as a reassembly reference.
- Keep component parts together as a group. Assemble screws and nuts into appropriate subgroups.
- When reassembling, clean all parts carefully, lubricate moving parts and replace all oil seals, o-rings, gaskets, washers and self-locking nuts.
- **For best results, use only original ICS® replacement parts.**

### General Recommendations

- Some procedures in this manual require the use of special tools. A complete tool kit for the 680ES is available from ICS®.
- Detailed carburetor maintenance and overhaul information is available in Walbro's Diaphragm Carburetor Service Manual. Walbro can be contacted at <http://www.walbro.com> or by calling 1.520.877.3000.

**THIS PAGE INTENTIONALLY LEFT BLANK**

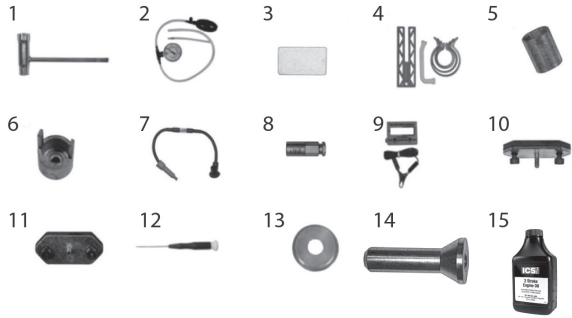

Key #	Part No.	Description
1	71521	Scrench 13-19 mm
2	71541	Pressure Gauge Bulb
3	71542	Coil/Flywheel Timing Shim
4	71543	Cylinder Assembly Clamps & Piston Stop
5	71544	Manifold Assembly Tool
6	71546	Shock Absorber Tool
7	71547	Spark Tester
8	71548	Flywheel Disassembly Tool
9	71565	Electronic Tachometer
10	71569	Induction Seal Flange with Screws
11	71570	Exhaust Seal Flange with Screws
12	71573	Tuning Screwdriver
13	73461	Flywheel Puller
14	73462	Main Bearing Driver Tool
15	571227	2-Stroke Oil, 50:1 Mix, 2.6 oz (77 ml) (6-Pack)
15	571228	2-Stroke Oil, 50:1 Mix, 2.6 oz (77 ml) (24-Pack)
Not Shown	71734	Gasket Set
Not Shown	70249	14T Bar Nose Sprocket Repair Kit

Engine Type	2-stroke, Air Cooled
Displacement	76.5 cc (4.7 cu-in)
Horsepower	3.7 kW (5 hp) @ 9,500 rpm
Torque	4.1 Nm (36.3 in-lbs) @ 6,500 rpm
Engine Speed	11500 +/- 500 rpm (max) 2,800 - 3,200 rpm (idle)
Chain Speed at Maximum Power	34.5 m/s (6800 ft/min)
Weight	9.5 kg (21 lbs) powerhead only
Powerhead Dimensions	46 cm (18 in) length 29 cm (11.5 in) height 25 cm (10 in) width
Air Filter	Water resistant polyester
Carburetor	Walbro WJ-136
Starter	Dust and water resistant
Ignition	Special water resistant electronic ignition
Clutch	Centrifugal, three shoe, single spring
Fuel ratio	2% (50:1) gasoline-to-oil
Fuel Capacity	0.88 liter (0.23 gallon)
Water Supply Requirement	Minimum 1.5 bar (20 psi)
Water Flow Requirement	Minimum: 4 lpm (1 gpm)
Guaranteed Sound Power Level, $L_{wa}$ (1)	117 dB(A) ( $K_{wa} = 3.0$ dB(A))
Equivalent Sound Pressure at the Operator's Ear, $L_{pA}$ (1)	101.0 dB(A) ( $K = 2.0$ dB(A))
Vibration, $a_{hv,eq}$ Concrete Cutting (2)	7.2 m/s <sup>2</sup> ( $K=1.0$ m/s <sup>2</sup> ) Front Handle 8.5 m/s <sup>2</sup> ( $K=1.0$ m/s <sup>2</sup> ) Rear Handle
Engine Break-in Period	One tank, without cutting, cycling throttle
Spark Plug	NGK BPMR8Y or Champion RCJ7Y Electrode gap 0.5 mm (0.020 in)

(1) Measured in accordance with ANSI S12.51-2012/ISO3741:2010

(2) Measured in accordance with ISO5349-1:2001 and ISO22867:2011

3 This section shows the two locations of the serial number.

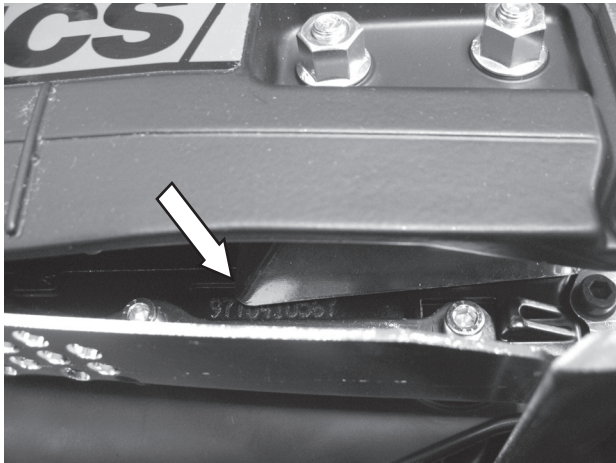

Starter Assembly

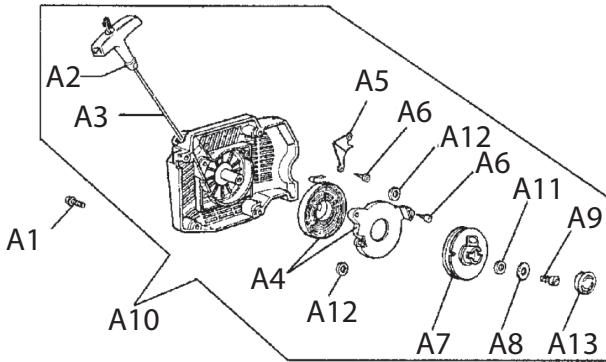

Key #	Part No.	Description
A1	73230	Bolt
A2	530208	Starter Rope Handle
A3	73904	Starter Rope
A4	531103	Starter Coil Spring & Housing
A5	71451	Starter Case Plate
A6	505380	Recoil Housing Screw
A7	528661	Starter Rope Pulley
A8	73905	Starter Pulley Washer
A9	73907	Starter Pulley Screw
A10	528637	Starter Cover Assembly
A11	530367	Starter Assembly Washer
A12	532026	Spring Housing Washer
A13	508853	Starter Assembly Cap



Flywheel and Starter Pawl Assembly

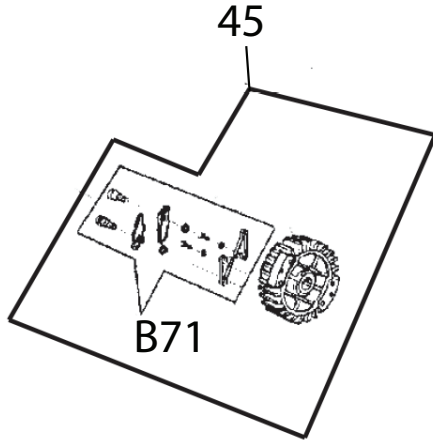
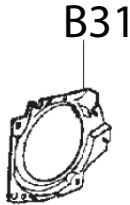
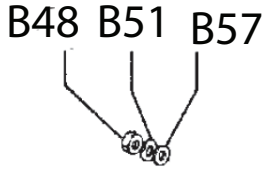

Key #	Part No.	Description
B31	531109	Flange, starter pulley 680
B45	528651	Flywheel 680
B48	73891	Nut, M8x1
B51	73911	Washer
B57	73912	Washer
B71	509163	Starter Pawl Assembly
Not Shown	71734	Gasket Set

Ignition Assembly

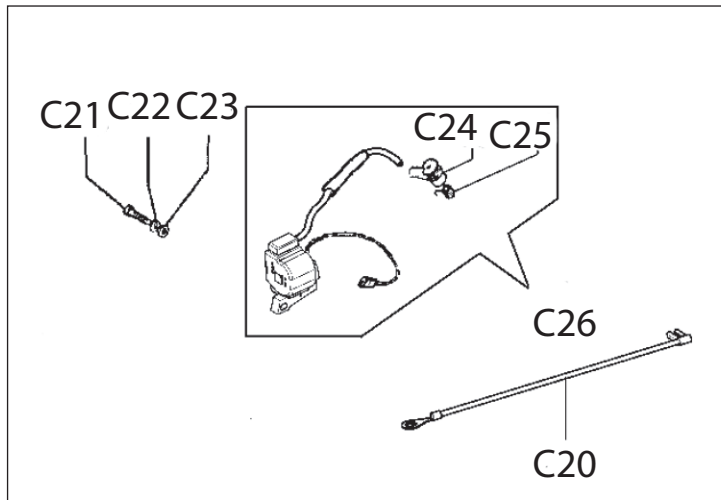

Key #	Part No.	Description
C20	576463	Ground Cable, 680ES
C21	73914	Screw m4x20
C22	73285	Wave Washer, 4.5mm
C23	73890	Washer
C24	73241	Spark Plug cap and spring kit
C25	73917	Spark Plug Spring
C26	576437	Ignition Coil 680ES

Cylinder & Intake Assembly

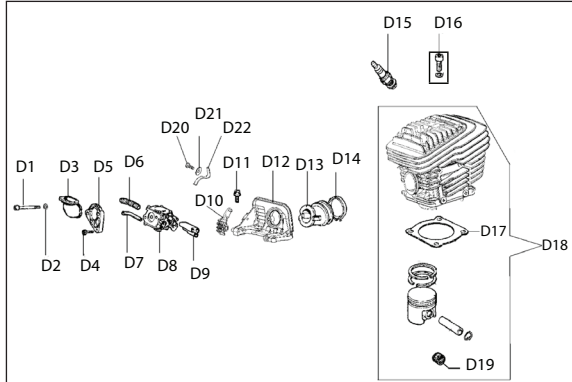

Key #	Part No.	Description
D1	505469	Wallwalker® Sidearm Screw
D2	73897	Washer
D3	71735	Intake Manifold
D4	73901	Intake Manifold Flange Screw
D5	73947	Intake Manifold Flange
D6	73888	Carburetor Spring
D7	545877	Carburetor Pulse Tube
D8	577754	Carburetor, Walbro WJ-136 680ES
D9	517547	Screw Guide
D10	576462	Multifunction Actuator for 680ES
D11	73866	Screw
D12	576435	Carburetor Support Bracket for 680ES
D13	73868	Intake Manifold
D14	545870	Intake Manifold Clamp
D15	514770	Spark Plug
D16	73874	Cylinder Bolt & washer
D17	545874	Gasket, Base
D18	548084	Complete Piston/Cylinder Assembly
D19	73869	Wrist Pin Needle Bearing
D20	577630	Screw, 680ES Motor
D21	577629	Washer, 680ES Motor
D22	577631	Detent Spring, 680ES Motor

Muffler Assembly

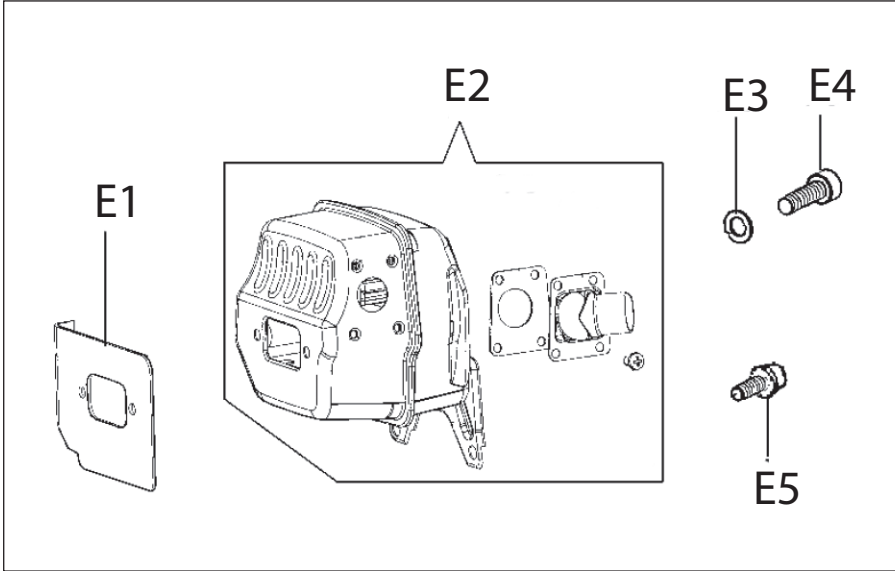

Key #	Part No.	Description
E1	545875	Cylinder to Muffler Gasket
E2	545872	Muffler Assembly
E3	73327	Washer, serrated
E4	73883	Muffler Mounting Screw
E5	73866	Screw, starter cover, lower muffler

Crankshaft Assembly

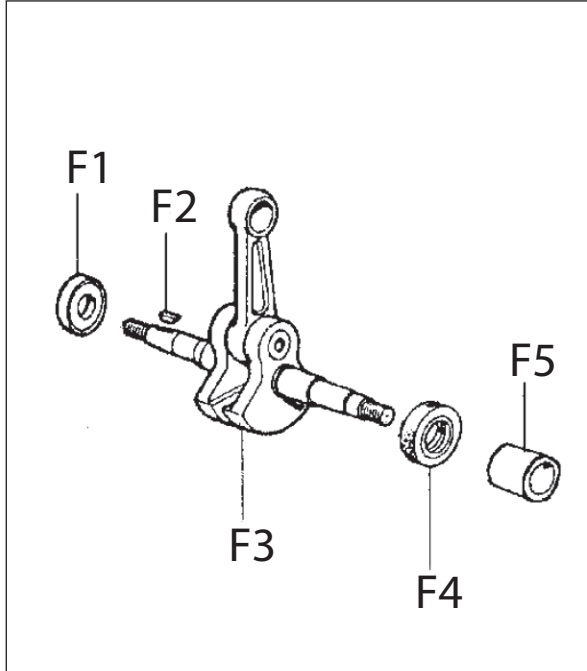

Key #	Part No.	Description
F1	73877	Crankshaft Seal Flywheel Side
F2	73878	Crankshaft Flywheel Woodruff Key
F3	71410	Crankshaft Assembly
F4	73209	Crankshaft Seal Clutch Side
F5	71452	Crankshaft Bushing

Clutch Assembly

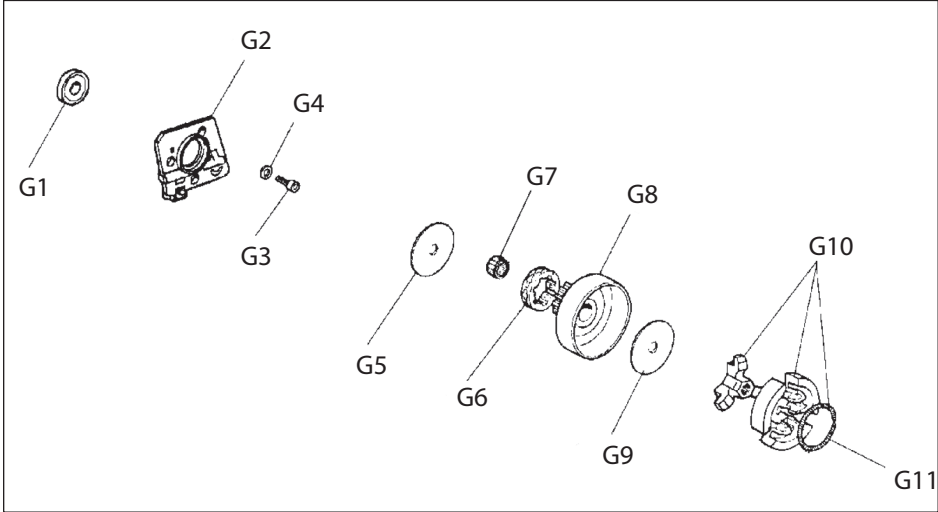

Key #	Part No.	Description
G1	73931	Sprocket Sealing Ring
G2	73949	Outer Crankcase Seal Body
G3	73940	Pump Body Bolt
G4	73285	Wave Washer, 4.5 mm
G5	73945	Clutch Spacer Washer
G6	70949	680/695 Drive Sprocket
G6	525496	680PG Drive Sprocket
G7	73939	Clutch Needle Bearing
G8	71520	Clutch Cup (includes p/n 73939)
G9	73941	Clutch Spacer Washer, Inside
G10	71419	Clutch Assembly
G11	73943	Clutch Spring

**Crankcase Assembly**

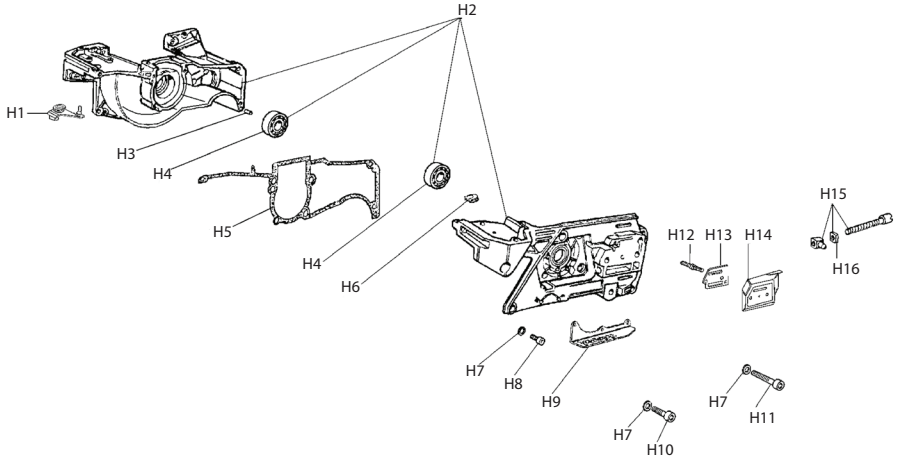

Key #	Part No.	Description
H1	73390	Fuel Line Grommet, Crankcase
H2	545967	Crankcase Assembly
H3	73281	Crankcase Dowel Pin
H4	545969	Crankshaft Bearing
H5	545968	Crankcase Gasket
H6	531107	Crankcase Grommet, Right Side
H7	73897	Washer
H8	73930	Crankcase Bolt, m5x22
H9	528657	Chain Guard, 680
H10	73397	Cover Guard Mounting Bolt
H11	73379	Screw
H12	73933	Bar Mounting Stud
H13	71740	Bar Mount Pad Spacer
H14	71738	Bar Mount Pad Cover Plate
H15	73935	Premium Tensioner Kit
H16	73936	Tensioner Screw Retainer

**Fuel Tank & Handle Assembly**

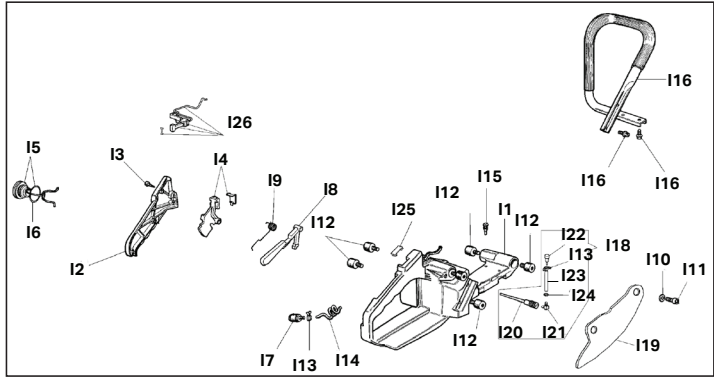

Key #	Part No.	Description
11	528655	Fuel Tank, 680
12	531105	Rear Handle Half, Black
13	73976	Rear Handle Screw
14	530479	Throttle Lever Assembly
15	530471	Fuel Cap , 680
16	73448	Fuel Cap O-Ring
17	73459	Fuel Filter
18	532028	Trigger Lockout Lever
19	73988	Trigger Lockout Lever Spring
110	73897	Washer
111	73982	Screw
112	73980	Shock Absorber
113	71588	Clip, Fuel Filter
114	73375	Fuel Line
115	73270	Bumper, Shock Absorber, Fuel Tank Top
116	73983	Front Handle Bolt
117	545971	Front Handle
118	71748	Fuel Breather Complete
119	71766	Water Deflector, Bottom
120	71751	Breather Tube Body
121	71759	Breather Tube Elbow
122	71761	Fuel Breather, Remote
123	71777	Breather Tube Extension
124	71760	Tube Clamp
125	581117	Plug, Fuel Tank and Handle Assembly for 680ES
126	577628	Throttle Rod Assembly, 680ES Fuel Tank



**Air Intake Assembly**

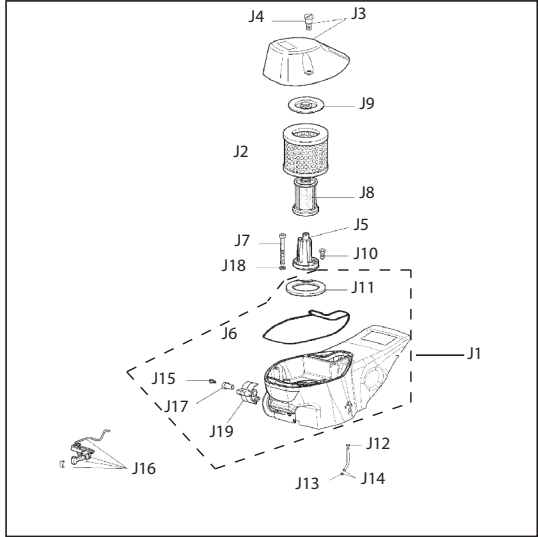

Key #	Part No.	Description
J1	576438	Cylinder Cover for 680ES (incl J6, J11, J15, J17, J19)
J2	71752	Air Filter Canister, Polyester
J3	530473	Air Filter Cover
J4	73992	Filter Cover Screw
J5	73338	Air Filter Mount
J6	71756	Filter Cover Gasket
J7	71771	Screw, Cylinder Cover, Long, Socket Head
J8	73336	Internal Screen
J9	71758	Air Filter Mount Screw
J10	73337	Filter Support Screw
J11	73335	Filter Canister Gasket
J12	71472	O-Ring
J13	71760	Tube Clamp
J14	505382	Compensator Tube
J15	576459	Screw, Torx T27
J16	577628	Throttle rod assembly for 680ES
J17	576461	Support Bushing, Multifunction lever
J18	73897	Washer
J19	576460	Multifunction lever, 680ES

Carburetor Repair Kit

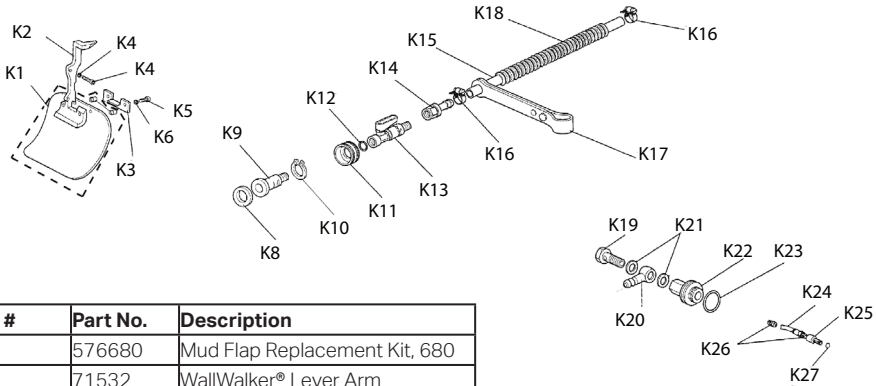

Key #	Part No.	Description
K1	576680	Mud Flap Replacement Kit, 680
K2	71532	WallWalker® Lever Arm
K3	71531	Guard Flap Clamp
K4	505469	Screw & Washer
K5	71479	WallWalker® Flap Screw
K6	73951	Washer
K8	71469	Water Hose Gasket
K9	545975	Fitting
K10	545976	Clip
K11	71457	Ring Nut
K12	71468	Water Hose O-Ring
K13	71458	Water Shut-Off Valve
K14	71454	Barb Fitting, 1/4 male thread
K15	71455	Tube
K16	71465	Hose Clamp
K17	71461	Hose Hanger
K18	71464	Water Hose Cover
K19	71463	Water Hose Screw
K20	71453	Fitting
K21	71456	Copper Washer
K22	73923	Water Tank Cap
K23	73448	Fuel Cap O-Ring
K24	71459	Tube
K25	71470	Fitting
K26	71471	Fitting
K27	71472	O-Ring

WallWalker & Water Delivery System

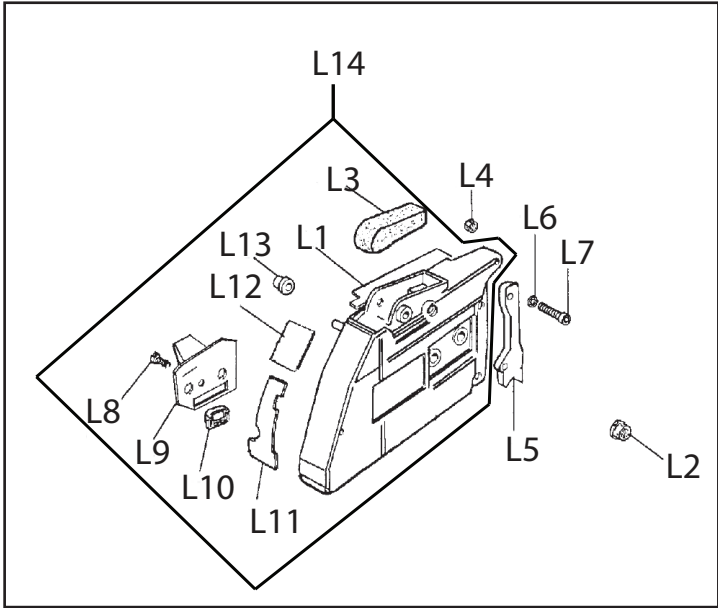

Key #	Part No.	Description
L1	71743	Side Cover Insert, Top
L2	73958	Side Cover Nut
L3	71462	Chain Cover Cap
L4	73367	Nut
L5	71533	WallWalker Side Arm
L6	73951	Lock Washer
L7	507355	WallWalker Side Arm Screw
L8	71487	Screw
L9	71447	Side Cover Plate
L10	73957	Lower Guard
L11	73972	Deflector, Lower
L12	73948	Deflector, Upper
L13	73310	Rubber Bumper Cover
L14	528659	Side Cover Assembly, Complete

CARBURETOR REPAIR KIT

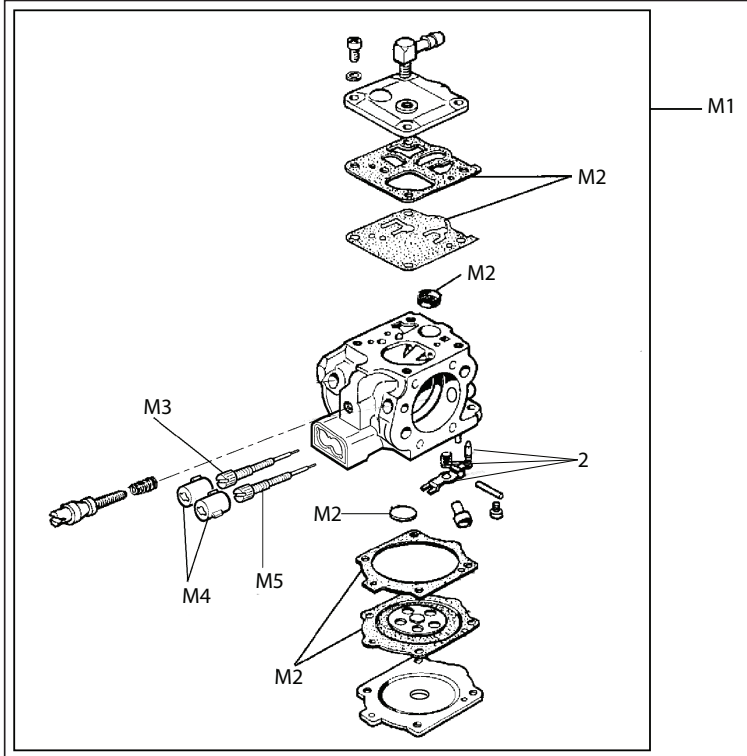

Key #	Part No.	Description
M1	577754	Carburetor, Walbro WJ-136
M2	73996	Carburetor Repair Kit
M3	577633	Needle Screw High, 680ES Carburetor
M4	577635	Limiter Cap
M5	577634	Needle Screw Low, 680ES Carburetor

## 5.1

Inspect air filter cover gasket.

A. Replace if permanently depressed or hard, due to slurry.

## 5.2 Inspect filter canister gasket.

A. Clean

B. Replace if necessary

## 5.3

Check air filter mount screws and lightly secure them if they are loose.

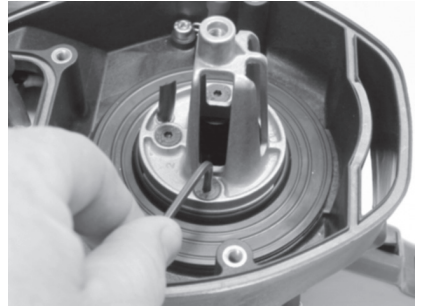
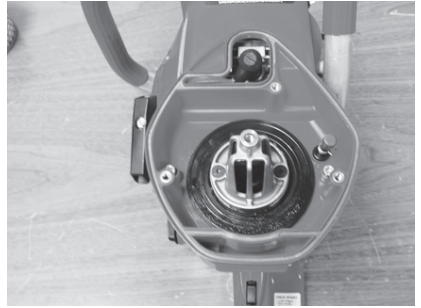

**6. This section covers the removal, inspection and installation of the spark plug.**

## 6.1

Remove spark plug cap and spring (spring is located inside of the cap).

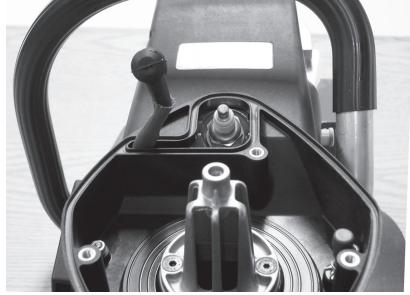

## 6.2

Loosen and remove the spark plug.



## 6.3

Inspect spark plug for damage or corrosion. Clean with a wire brush.



6.4

Gap if necessary to 0.02" (0.5mm).

**NOTE:**

If the spark plug must be replaced, refer to the spark plug reference guide at the end of this manual to select the correct replacement plug.



6.5

Assemble in the reverse order.

Make sure the plug boot is seated completely.

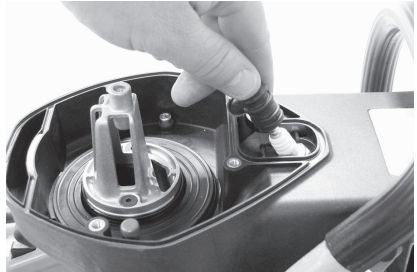

**7. This section covers clutch removal, rim sprocket removal, inspection and assembly. Refer to sections 5 and 6 if needed.**

## 7.1

Insert piston stop tool into spark plug hole.



## 7.2

Pull starter handle until piston stops against tool.

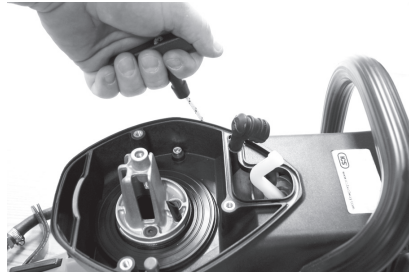

## 7.3

Remove clutch

**CAUTION** Left hand threads - rotate clockwise to loosen.

**NOTE:** If an impact wrench is available steps 7.1 and 7.2 do not need to be performed.

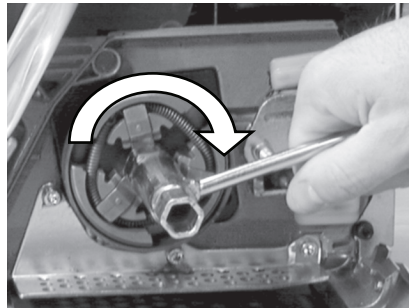



7.4

Remove all drive components.

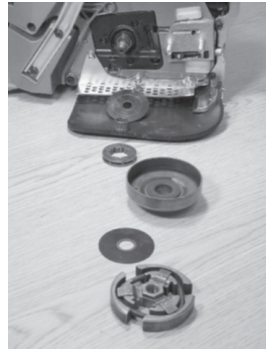

7.5

Inspect the clutch shoes for wear.

A. Replace if the shoe has less than 0.04" (1 mm) of material, as shown.



7.6

Inspect spring for cracks.

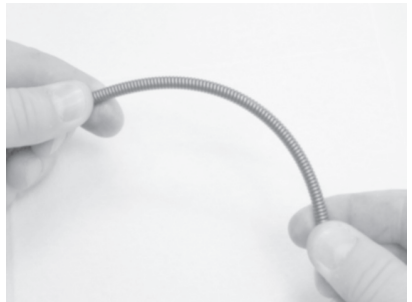

7.7

Assemble clutch shoes as shown.

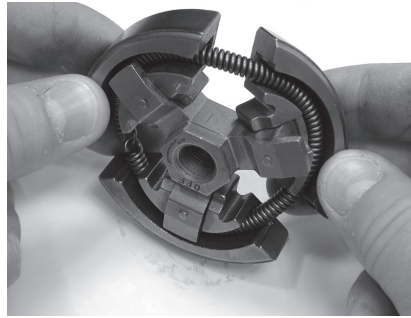

7.8

Finish installation of clutch shoe as shown.

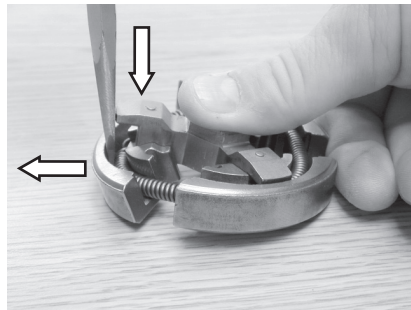

7.9

Inspect the rim sprocket for wear.

A. Replace if the rim sprocket teeth are worn to points, as shown on right.

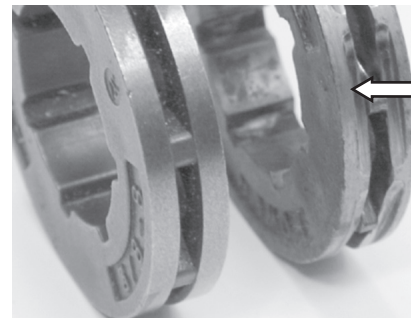

## 7.10

Clean and Assemble.

- A. Clean all parts in solvent.
- B. Grease clutch cup bearing with a waterproof grease.
- C. Assemble clutch spacer washer, bearing, clutch cup with rim sprocket, and inside clutch spacer washer.



## 7.11

Install clutch.

Torque to 295 in-lbs (33.3 Nm).

**CAUTION** Left hand threads.

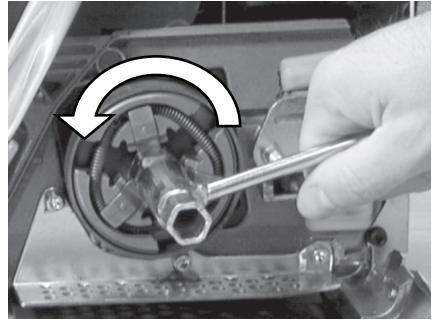

**8. This section covers the removal of the starter cover, replacement of the starter rope, and replacement of the recoil spring.**

8.1

Remove starter cover screws (4).

8.2

Remove starter cover assembly from the power cutter.

8.3

Remove starter cord shield screws.

8.4

Relieve spring tension.

- A. Pull 4-6" (10-15 cm) of rope out.
- B. Line rope up with notch on pulley.
- C. Slowly rotate pulley counter-clockwise until spring pressure is released. Use thumb as brake.

8.5

Remove starter pulley screw and washer.

**NOTE:** Hold starter cover firmly.

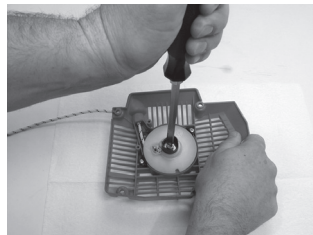
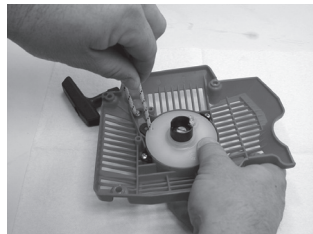
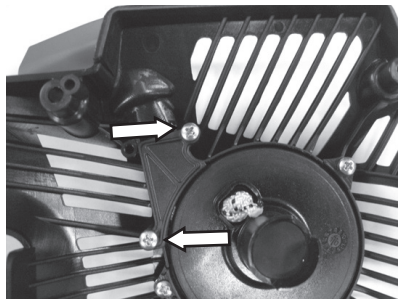

## 8.6

Remove starter pulley.

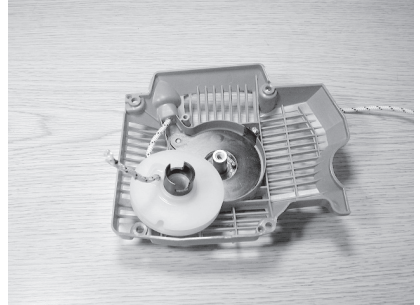

## 8.7

Inspect coil spring.

A. Replace if spring hook is damaged. Attempting to re-bend the spring hook may cause the hook to break off.

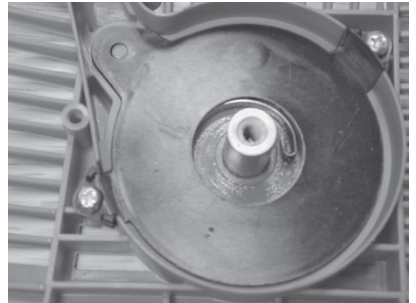

B. Carefully remove coil spring and housing to prevent spring from unwinding.

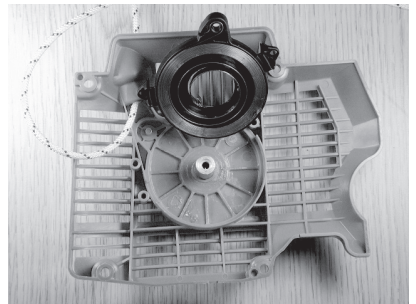

8.8 Lubricate with lightweight oil.

8.9 Replace parts carefully.

## 8.10

Inspect pulley spring catch.

- A. Clean with cleaning solution.
- B. Replace if worn or broken.

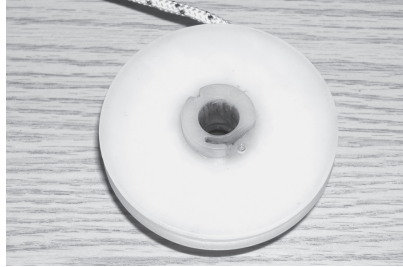

## 8.11

Install starter rope and tie knot.

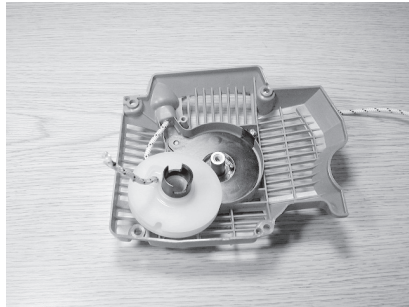

## 8.12

Install pulley.

- A. Wind rope onto pulley clockwise leaving 4-6" (10-15 cm) out.
- B. Make sure that the pulley spring catch is in the spring hook.

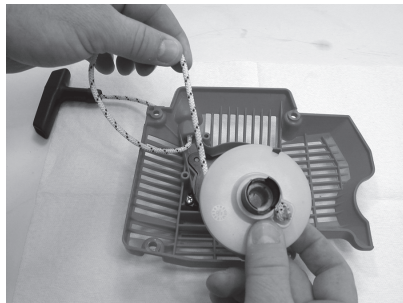

## 8.13

Install center screw, spacer and washer.

- A. Use Loctite®.242.
- B. Torque to 26 in-lbs (2.9 Nm).

## 8.14

Wind the recoil spring.

- A. Line rope up with notch on pulley.
- B. Rotate the pulley with the rope clockwise 5 times.
- C. Untangle rope and release.

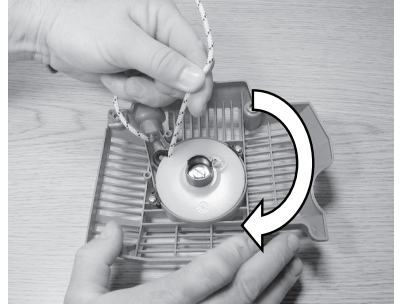

## 8.15

Assemble starter cord shield.

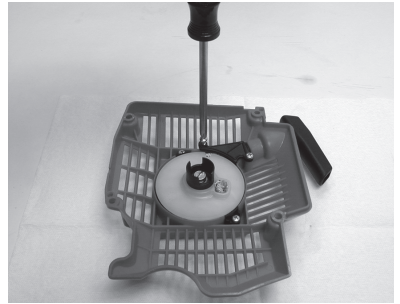

## 8.16

Remove starter pawl screws, pawls, spring and plain washer.

NOTE: Piston stop tool may be required to remove the starter pawl screws.

## 8.17

Inspect and clean pawl components.

- A. Inspect the components. Replace if necessary.
- B. Clean the components with a brush and solvent.

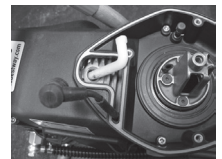

8.18

Assemble components

- A. Make sure the spring is in the correct position.
- B. Use Loctite® 242 on the pawl screws.
- C. Torque to 60 in-lbs. (6.8 Nm).

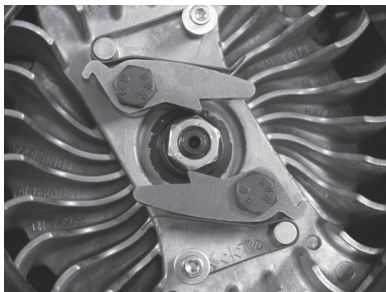

8.19

Install starter cover.

- A. Pull out cord 4-6" (10-15cm).
- B. Slowly release while placing cover to allow pawls to engage.



8.20

Install starter cover screws.

- A. Use Loctite® 242.
- B. Torque to 60 in-lbs. (6.8 Nm).





**9. This section covers the removal, inspection and assembly of the WallWalker® and guard flap.**

9.1

Inspect WallWalker® tip.

A. If the tip is worn, as shown, replace.

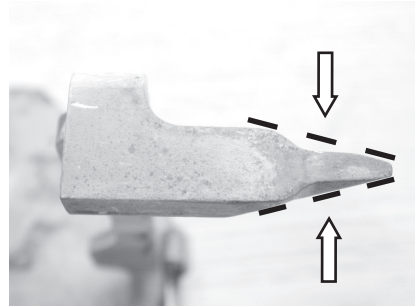

9.2

Remove bar mount pad.

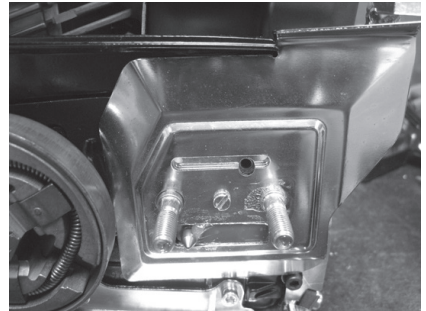

9.3

Remove crankcase screws and wave washers.

Remove WallWalker® from the power cutter.

Install new WallWalker®.

Assemble in reverse order.

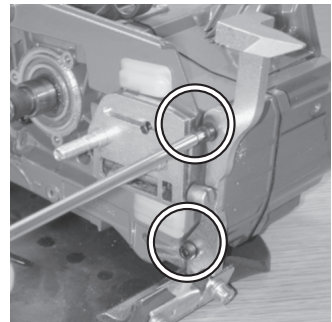

9.4

Remove guard flap screws and washers.

9.5

Remove and inspect guard flap.

A. Replace the flap if it is torn or damaged in any way.

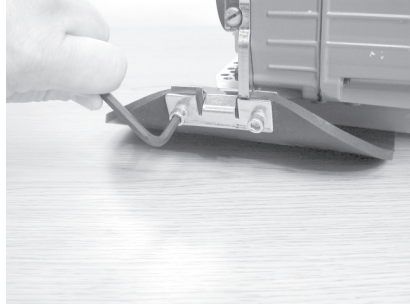

9.6

Reassemble in the reverse order.

A. Install guard flap screws and washers.

B. Use blue Loctite® 242.

C. Torque to 43 in-lbs. (4.8 Nm).

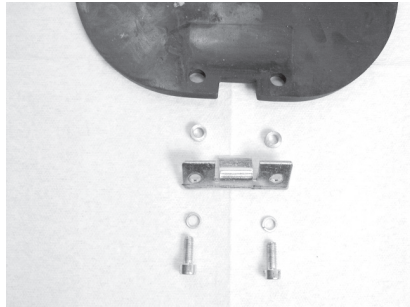

**10 This section covers the disassembly and assembly of the cylinder cover. Removal of the air intake components and front handle is necessary. Refer to sections 1 and 14 if needed.**

## 10.1

Remove the air filter mount screws.

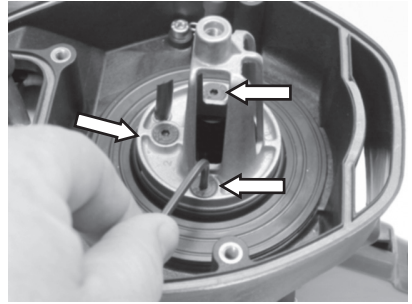

## 10.2

Remove the cylinder cover screws (3).

## 10.3

Remove spark plug lead from cylinder cover.

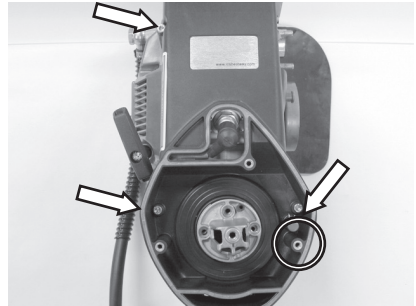

## 10.4

Remove fuel tank breather cap and clamp.

## 10.5

Partially remove intake manifold from cylinder cover.

## 10.6

Remove cylinder cover.

- A. Pull up on front.
- B. Push intake manifold through hole.
- C. Make sure throttle linkage is disengaged from cylinder cover.
- D. Guide fuel breather tube and compensator tube through cylinder cover.

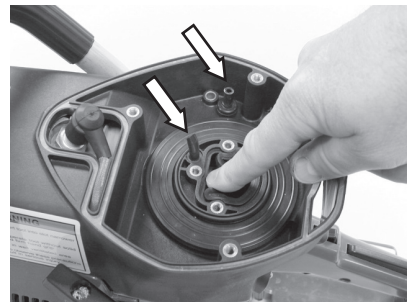

10.7

Lift off cylinder cover.

10.8

Inspect cylinder cover for damage.

A. Replace if necessary.

10.9

Check cylinder cover water seal and filter cover gasket are in place and in good condition.

A. Replace if necessary.

10.10

Reassemble stop switch leads.

10.11

Make sure carburetor screw boot is in place.

10.12

Lubricate compensating tube and fuel tank breather tube with soapy water, guide through cylinder cover (install compensating tube first).

NOTE:

Be careful as to not pull tubes away from their point of connection. Approximately 3/4" 2 cm) of tube should protrude from cylinder cover.

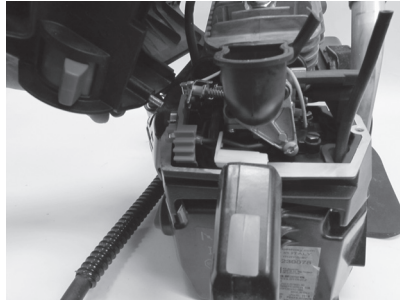

**screw boot**

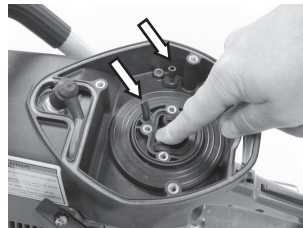
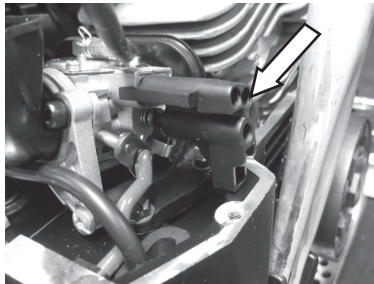

## 10.13

Install cylinder cover.

- A. Pull spark plug lead into slot in cylinder cover.
- B. Make sure throttle rod assembly is seated between crankcase and cylinder cover.
- C. Push the cylinder cover down on the crankcase, guide intake manifold into cylinder cover.
- D. Install the cylinder cover screws. Use Loctite® 242. Torque to 35 in-lbs. (4.0 Nm).
- E. Install fuel tank breather and clamp.

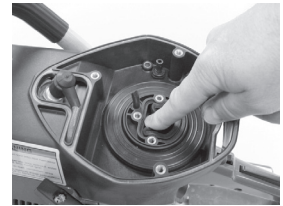
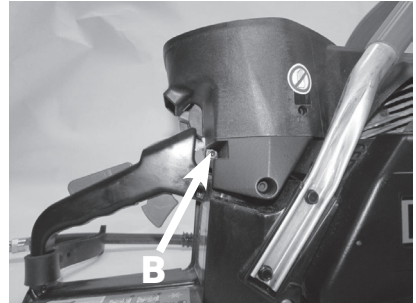

## 10.14

Install air filter mount.

- A. Guide carburetor compensating tube through air filter mount. Make sure manifold sits flat over lip on cylinder cover.
- B. Install air filter mount screws (3) using Loctite® 242.
- C. Torque to 43 in-lbs (4.9 Nm.)

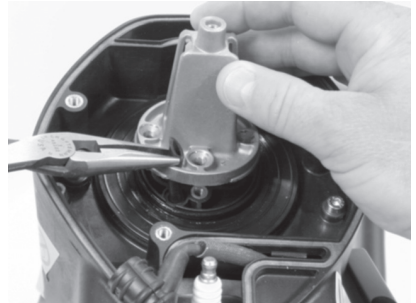

## 10.15

Install air filters and cover.

- A. Install pre-filter.
- B. Install clean air filter.
- C. Install air filter flange and tighten.
- D. Install air filter cover and tighten.



**11. This section covers the disassembly, inspection, and assembly of the muffler. Removal of the WallWalker® and cylinder cover is necessary. Refer to sections 7 and 10 if necessary.**

## 11.1

Remove muffler support screws.

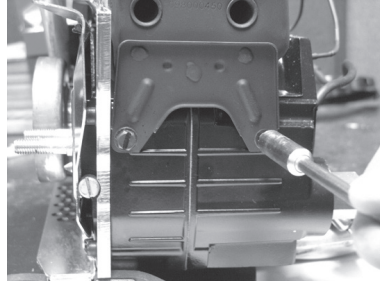

## 11.2

Remove muffler screws located inside the muffler.

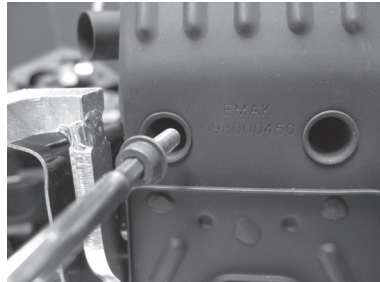

## 11.3

Remove muffler and heat shield gasket.

A. Replace any damaged components.

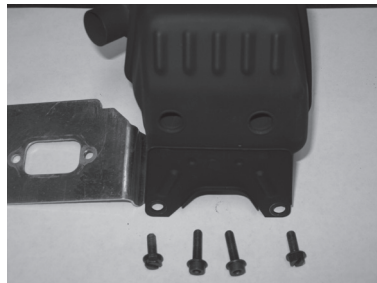

## 11.4

Install muffler.

- A. Insert muffler screws (2) into muffler.
- B. Hold muffler screws in place with heat shield gasket.
- C. Thread muffler screws into cylinder with Loctite®242. Torque to 78 in-lbs. (8.8 Nm).



## 11.5

Install bottom (2) muffler support screws with Loctite®242.

- A. Torque top screws to 78 in-lbs. (8.8 Nm).
- B. Torque bottom screws to 52 in-lbs. (5.8 Nm).

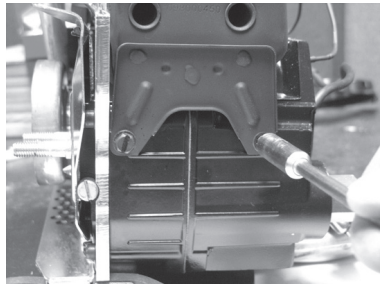

**12. This section covers the removal and installation of the carburetor. Removal of the air intake components and cylinder cover is required. Please refer to section 5, 10 or 11 if necessary. Carburetor tuning is covered in section 23.**

NOTE: All 680ES power cutters are equipped with carburetor model WJ-136.

## 12.1

Remove throttle rod assembly.

A. Pull the trigger to push the rod assembly out of the handle.

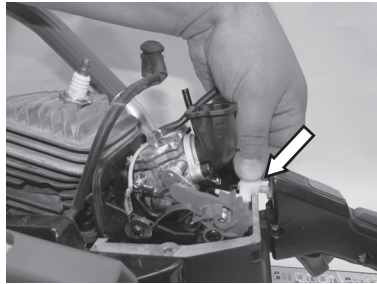
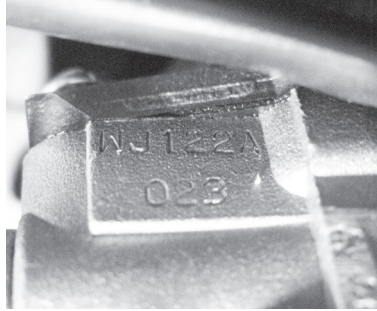

## 12.2

Remove carburetor support screw (1) with Torx or straight blade screwdriver.

## 12.2a

Remove carburetor body screws (2) with 4mm allen wrench

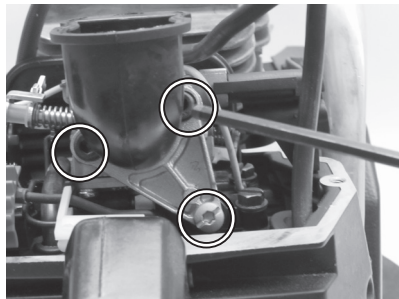



12.2b

Remove air intake boot.

12.2c

Remove groundwire.

12.3

Remove fuel line.

12.4

Remove pulse tube.

12.5

Remove throttle linkage from carburetor.

12.6

Remove carburetor compensator tube on top of carburetor.

12.7

Assemble in the reverse order.

A. Torque carburetor body screws to 43 in-lbs. (4.9 Nm).

B. Torque supporter screw with blue Loctite® to 43 in-lbs. (4.9 Nm).

Note: If installing a new carburetor, it must be tuned to factory specifications (carburetors are not factory tuned).

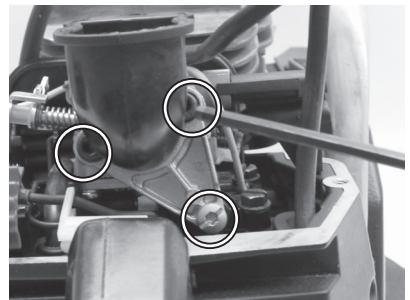
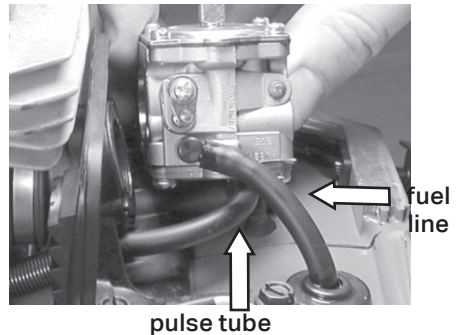
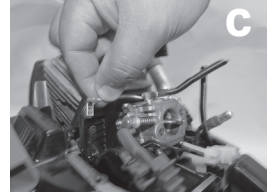
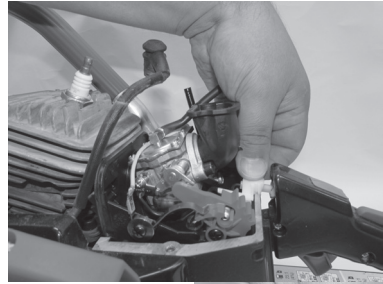

**13. This section covers the removal, inspection and assembly of the cylinder, piston and related components. Removal of several component groups is required. Refer to sections 5, 6, 10 and 12 if necessary.**

**NOTE:**

When replacing the 680ES cylinder and piston it is necessary to tune the carburetor prior to returning the power cutter to service. See section 23.

13.1

Remove the multifunction actuator

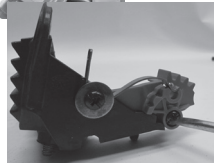
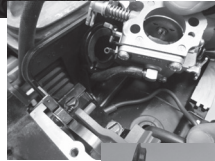
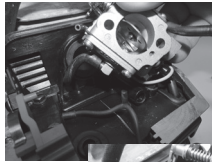

13.2

Remove carburetor base screws.

A. Remove carburetor base from rear manifold. Push rear manifold through carburetor base while holding carburetor base.

B. Remove carburetor base from pulse tube.

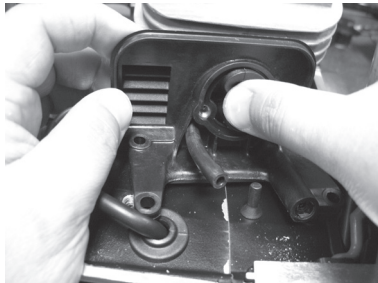

## 13.3

Remove pulse tube and protective spring from cylinder base.

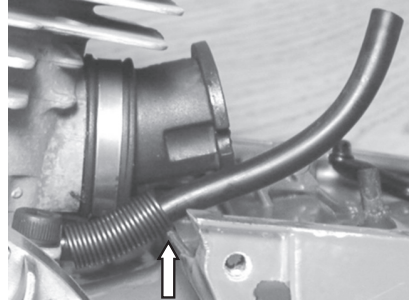

## 13.4

Remove rear manifold clamp.

## 13.5

Remove rear manifold from cylinder.

A. Inspect for holes and tears in the manifold, replace if damaged.

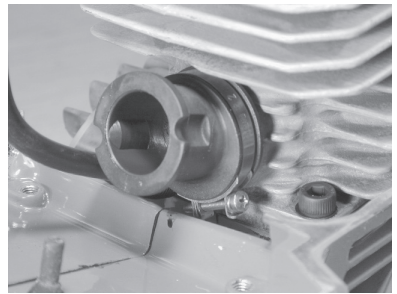

## 13.6

Remove cylinder screws (4) and wave washers.

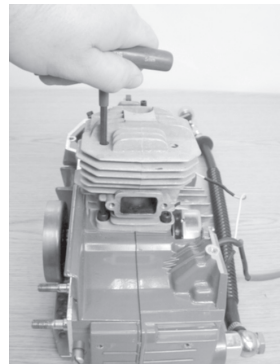

13.7

Remove cylinder.

A. Remove cylinder gasket and clean crankcase mating surface.

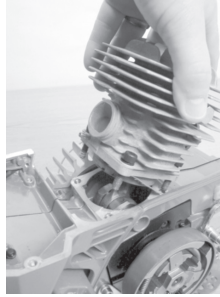

13.8

Remove wrist pin retaining clips (2)



13.9

Press wrist pin out with an 8mm deep socket.

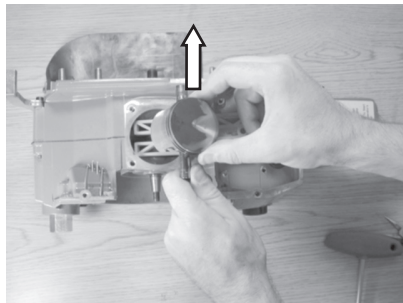

13.10

Remove piston and inspect. Replace if damaged.

13.11

Remove wrist pin bearing.

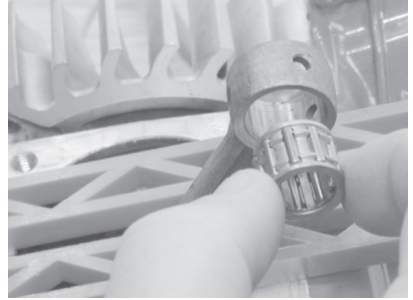

13.12

Cylinder gasket.

- A. Oil gasket with ICS® 2-stroke engine oil.
- B. Install and align holes and notch.

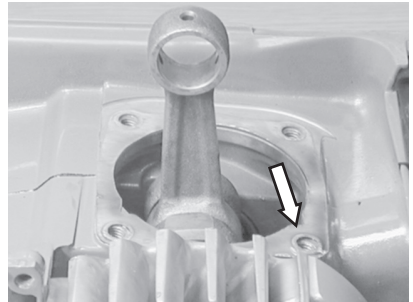

13.13

Install wrist pin bearing in rod.

- A. Oil bearing with ICS® 2-stroke engine oil.

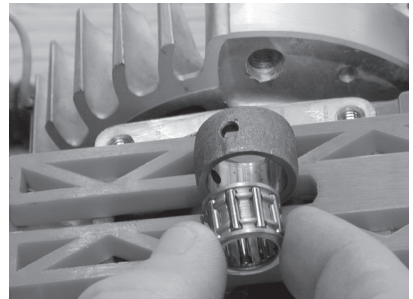

13.14

Install rings.

Install bottom ring first. Installing the bottom ring over the top ring may cause the ring to break.



13.15

Ring orientation.

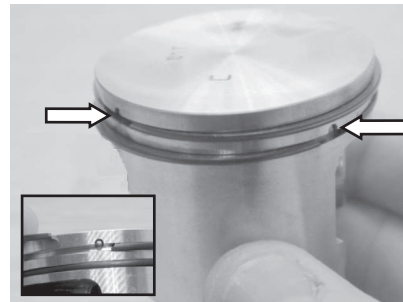

13.16

Install (1) wrist pin retaining clip.



13.17

Make sure wrist pin retaining clip is in the proper orientation.

 Improper installation may result in serious engine damage.



13.18

Partially install wrist pin.



13.19

Align piston in correct orientation.

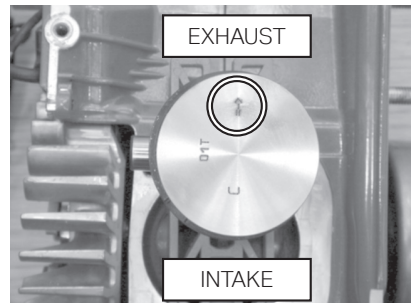

## 13.20

- A. Oil piston with ICS® 2-stroke oil.
- B. Align wrist pin with wrist pin bearing.
- C. Complete wrist pin installation.
- D. Install second wrist pin retaining clip.

Make sure wrist pin retaining clip is in the proper orientation (see 13.16).

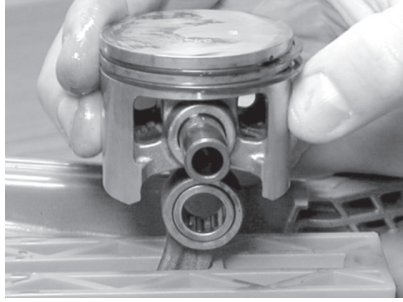

## 13.21

Install cylinder.

- A. Lubricate cylinder bore with ICS® 2-stroke oil.
- B. Compress rings with ring compression tool.
- C. Slide cylinder onto piston, pushing ring compression tool down.

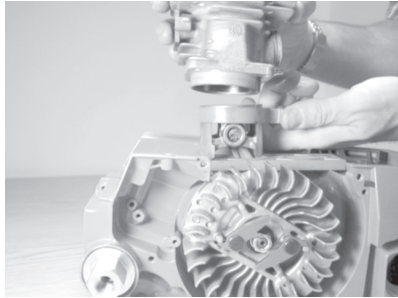

## 13.22

Install cylinder.

- A. Remove ring compression tool.
- B. Slide cylinder down piston and into crankcase.
- C. Align cylinder bolt holes with crankcase.

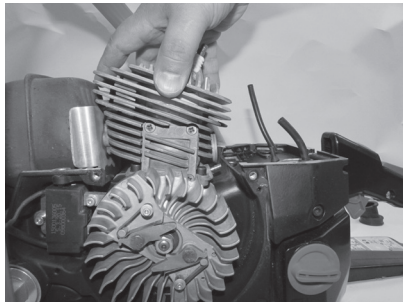



## 13.23

Install 4 cylinder screws and washers.

- A. Use Loctite®242.
- B. Torque bolts to 95 in-lbs. (10.7 Nm).

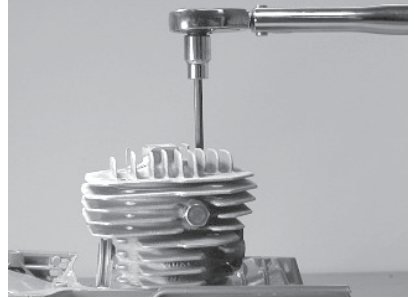

## 13.24

Install rear manifold.

- A. Lubricate rear manifold with ICS® 2-stroke oil.
- B. Push rear manifold onto cylinder intake.
- C. Align rear manifold seam with cylinder and crankcase seam.

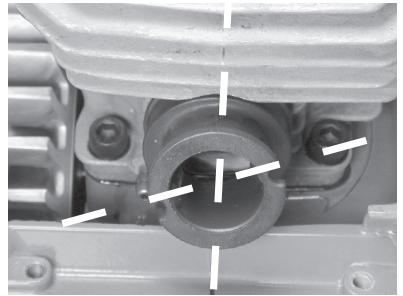

## 13.25 Install rear manifold clamp.

- A. Torque to 11 in-lbs. (1.2 Nm).

**⚠** Do not over tighten, damage to rear manifold may cause engine damage.

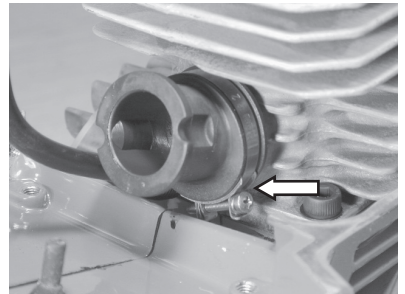

13.26

Install the pulse tube onto cylinder barb.

13.27

Install protective spring onto pulse tube.

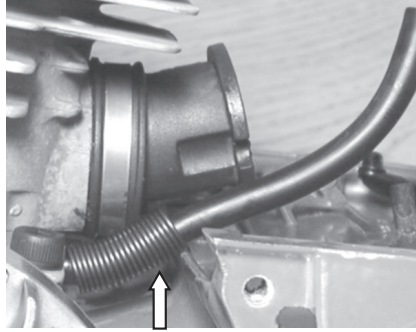

13.28

Install carburetor base.

- A. Slip pulse tube into and through carburetor base.
- B. Ensure bullet clip wire seats under the carburetor bracket
- C. Slip rear manifold into and through carburetor base.
- D. Make sure rear manifold lip is flat.

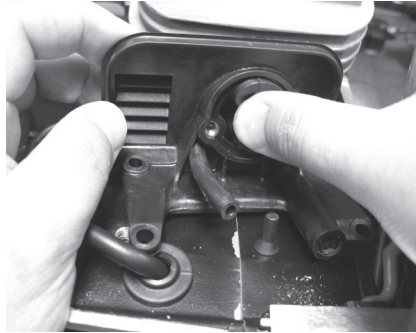

13.28

Install carburetor base screws.

- A. Use Loctite® 242 on (3) screws without ground wire.
- B. Make sure to include stop switch wire (installed on left rear screw).
- C. Torque to 35 in-lbs. (4 Nm).

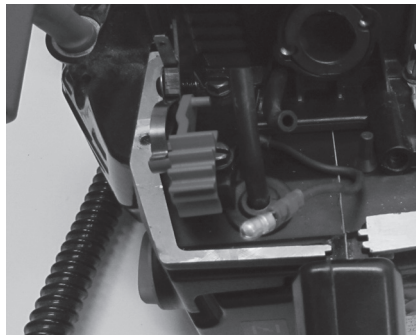

**14. This section covers water hose and water tank cap.**

14.1

Loosen hose clamp screw.

14.2

Remove water connection from hose.

14.3

Remove hose from hose hanger.

14.4

Remove water hose connector.

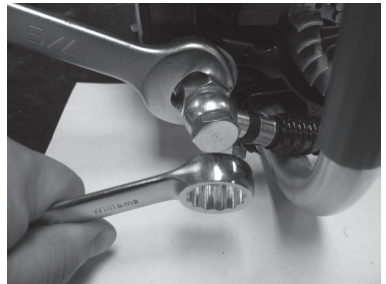
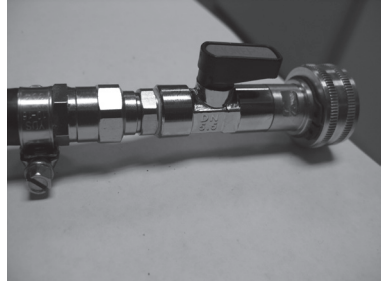

14.5

Unscrew water tank cap from the power cutter (7/8 wrench).

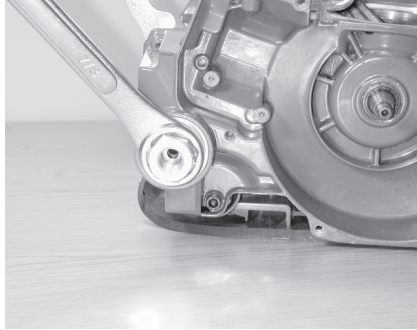

14.6

Release water tank cap from water tank tube.

A. Depress orange fitting (as shown) to release water tank tube.

14.7

Assemble in reverse order.

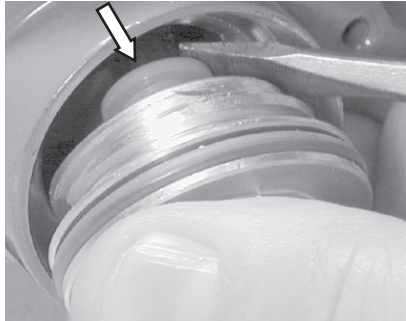

**15. This section covers the removal, inspection, and installation of the ignition coil. Removal of the starter is required. Refer to section 8 if necessary.**

15.1

Remove starter flywheel shroud by unhooking wires.

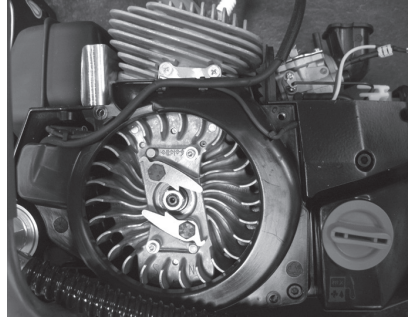

15.2

Remove ignition coil screws, wave washers and plain washers.

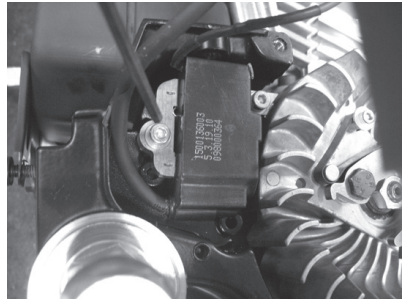

15.3

Remove ignition coil.

15.4

Inspect.

- A. Look for cracks/missing insulation.
- B. Clean flywheel magnets and coil if rusty.

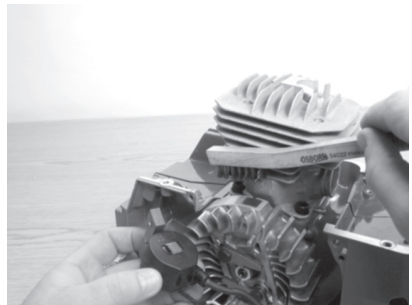

## 15.5

Install ignition coil.

- A. Place ignition coil shim (0.012")
- B. Set ignition coil in place.
- C. Install ignition coil screws, wave washers, and plain washers with Loctite® 242.
- D. Holding shim, rotate flywheel magnet around to coil.
- E. Torque ignition coil screws to 26 in-lbs.(3 Nm).
- F. Remove shim, rotate flywheel to check clearance.

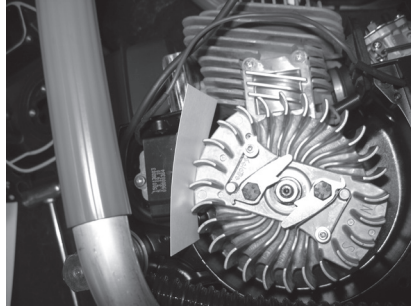

## 15.6

Install flywheel shroud.

## 15.7

Route ignition stop switch wire through crankcase into carburetor chamber.

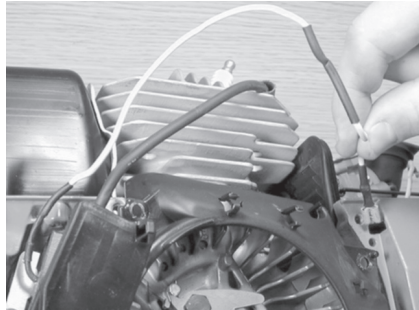

## 15.8

Complete ignition wire routing.

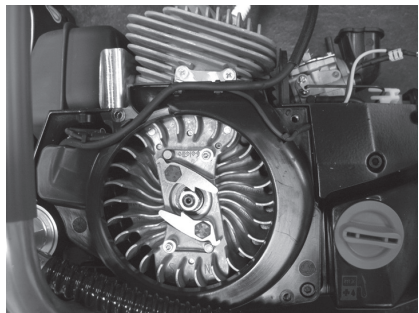

**16. This section covers the removal, inspection, and installation of the flywheel. Removal of the starter and spark plug is required. Refer to sections 6 and 8 if necessary.**

16.1

Insert piston stop.

16.2

Remove flywheel nut, wave washer, and plain washer.

16.3

Screw on flywheel removal tool finger tight. Unscrew tool 1/2 turns leaving approximately 1/8 inch (5 mm) space between tool and flywheel.

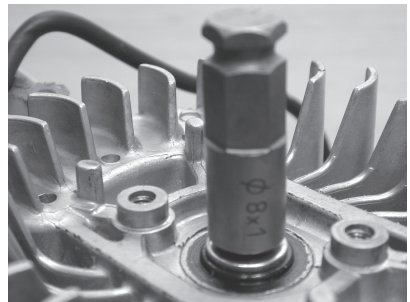
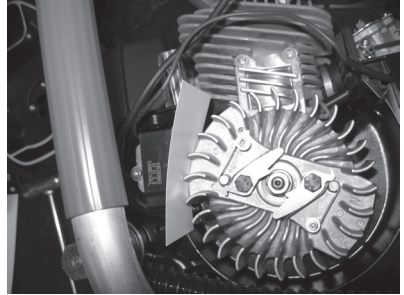

16.4

Using pliers, hold power cutter up by magnet counterweight.

16.5

Strike flywheel removal tool with a ball peen hammer. The flywheel should release from crankshaft.

16.6

Inspect and clean flywheel. Replace if any of the fins are broken.

16.7

Inspect woodruff key.

16.8

Install flywheel, plain washer, wave washer, and flywheel nut.

A. Torque nut to 260 in-lbs (29.3 Nm.)

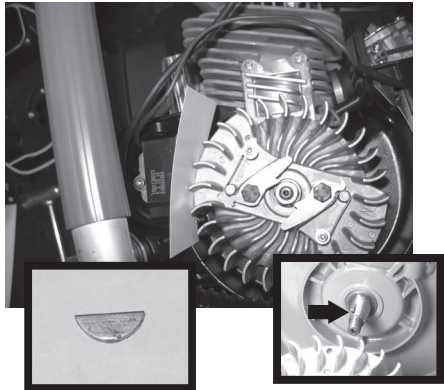
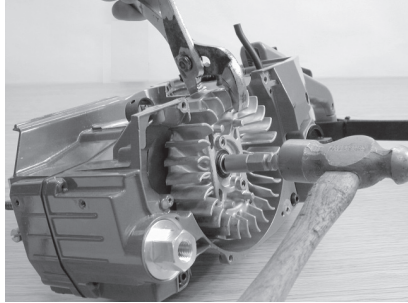



**17. This section covers the removal, inspection, and installation of the bottom guard.**

- A. Remove bottom guard screws and split washers.
- B. Inspect bottom guard.
- C. Replace if damaged.
- D. Assemble in reverse order.

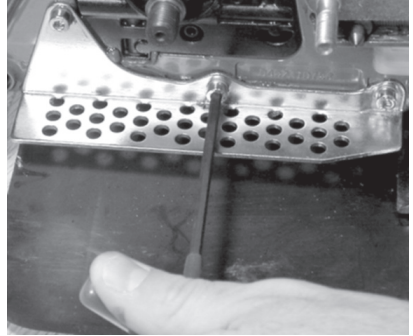

**18. This section covers the removal, inspection, and installation of the front handle.****18.1**

Remove front handle screws on right side.

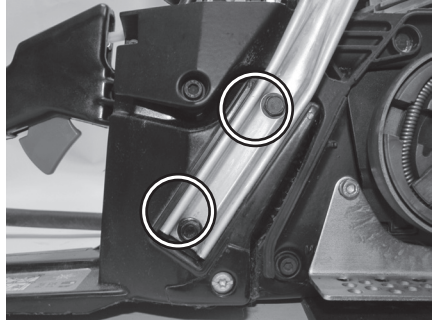
**18.2**

Remove front handle screws on bottom.

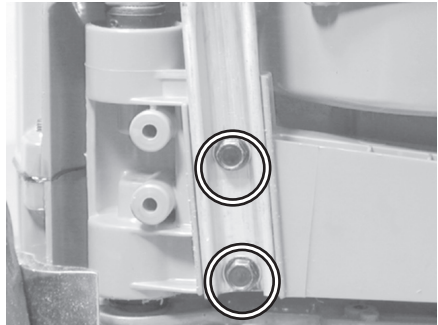
**18.3**

Install front handle

- A. Roll front handle into place.
- B. Install front handle screws (4).
- C. Use Loctite®242.
- D. Torque to 69 in.-lbs. (7.8 Nm).

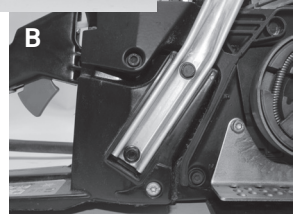
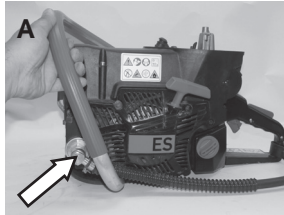

**19. This section covers the disassembly, inspection, and assembly of the vibration isolators, fuel tank and rear handle.**

19.1

Remove vibration isolator screws and wave washers on clutch side of the power cutter.

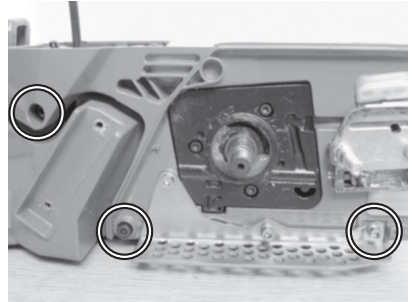

19.2

Remove vibration isolator screws and wave washers on flywheel side of the power cutter.

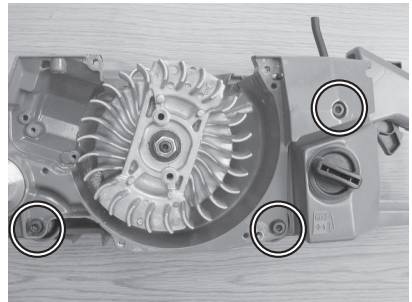

## 19.3

Separate crankcase and fuel tank.

NOTE: Power Cutters have a rubber water deflector connected to the (2) bottom vibration isolators on the clutch side (circled).

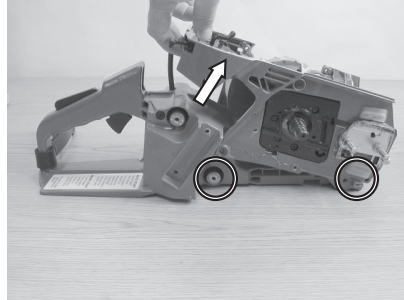

## 19.4

Remove vibration isolators from fuel tank (6) if necessary.

\* Shock absorber tool p/n #71546 should be used for removal and installation.

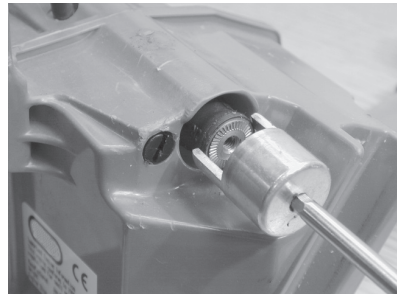

## 19.5

Assemble in reverse order.

NOTE: During assembly be careful to avoid kinking the fuel line.

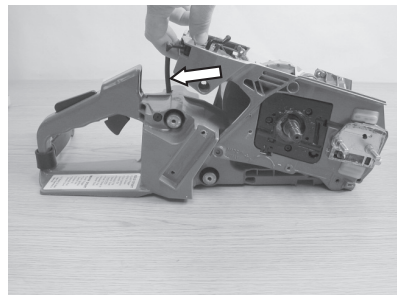

**20. This section covers the removal, inspection and assembly of the crankcase seals and crankshaft bearings.**

20.1

Remove outer crankshaft seal housing screws and wave washers.

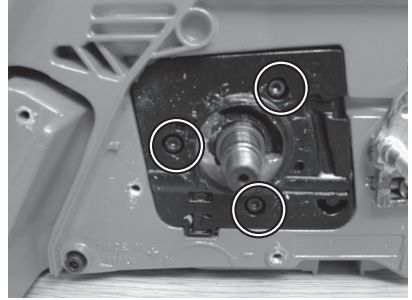

20.2

Remove crankcase bolts.

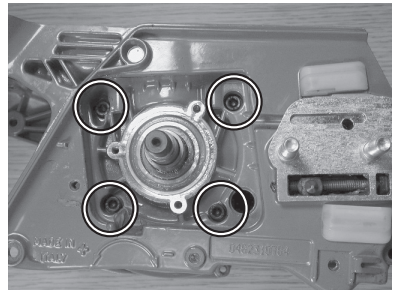

20.3

Heat the flywheel side crankcase with heat gun for 5 minutes, approximately 150° F (65.5° C).

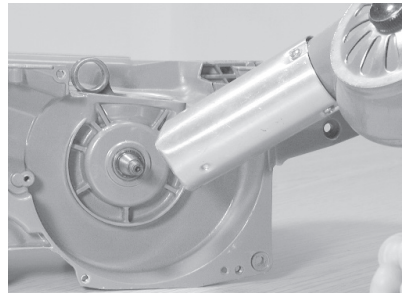

## 20.4

Remove the flywheel side crankcase — tap crankshaft with plastic mallet.

- A. Suspend above work surface.
- B. Tap with mallet.

**NOTE:** A nut should always be placed on a threaded shaft when pounding or pressing on it.



## 20.5

Remove the flywheel side crankcase seal with 1/2" (13 mm) socket.

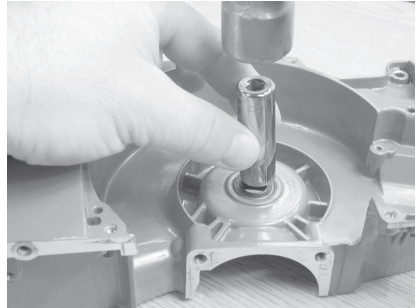

## 20.6

Heat the clutch side crankcase with heat gun to 150°F (65.5°) C.

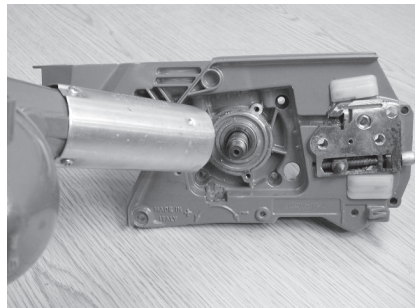

## 20.7

Remove crankshaft from the clutch-side crankcase tap crankshaft with a plastic mallet.

- A. Suspend above work surface.
- B. Tap with plastic mallet.

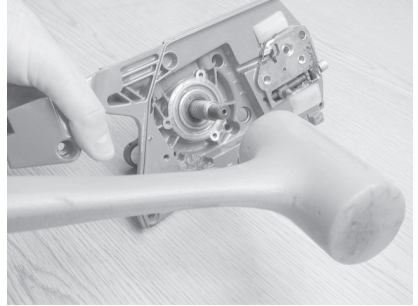

## 20.8

Remove the bearing from the flywheel side of crankshaft.

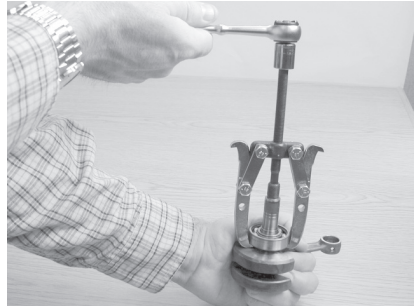

## 20.9

Remove the bearing, seal, and bushing from the clutch side of crankshaft.



20.10

Clean mating crankcase faces.

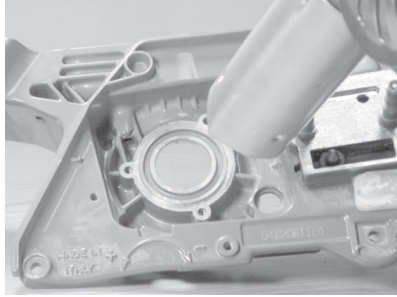

20.11

Heat crankcase halves to 150° F (65.5°) C.

20.12

Install bearing into crankcase halves.

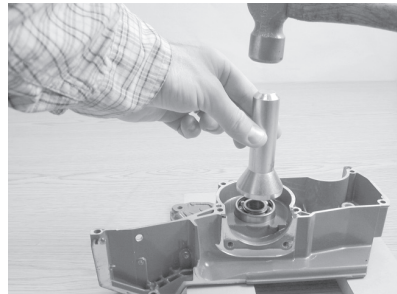

20.13

Tap with bearing driver and mallet.

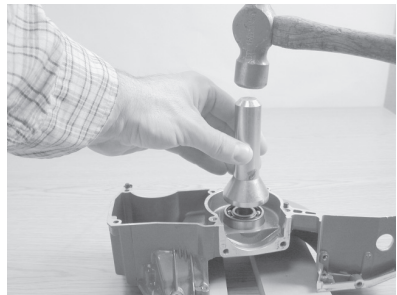

20.14

Repeat with other half.



20.15

Install crankshaft into clutch side of case.

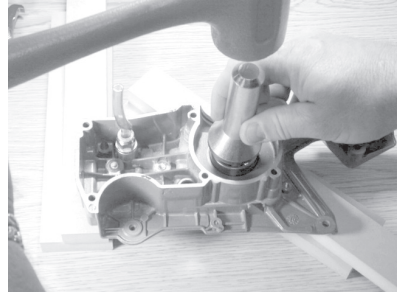

20.16

Place clutch side crankcase seal on crankshaft.

A. Tap lightly with bearing driver and mallet.

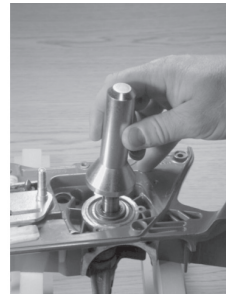

20.17

Coat crankcase gasket with ICS® 2-stroke engine oil.

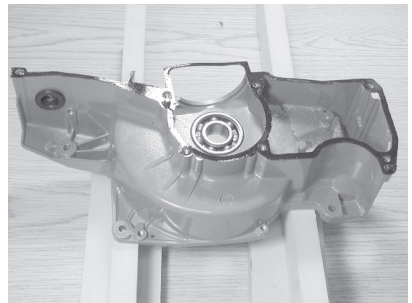

20.18

Align crankcase gasket on flywheel side crankcase pins.

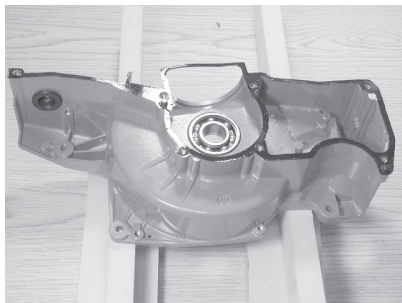

20.19

Place crankcase halves together and align crankcase pins.

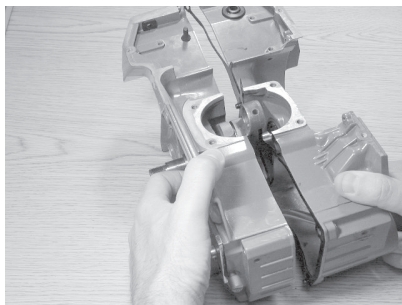

20.20

Assemble crankcase halves — tap with bearing driver and mallet.

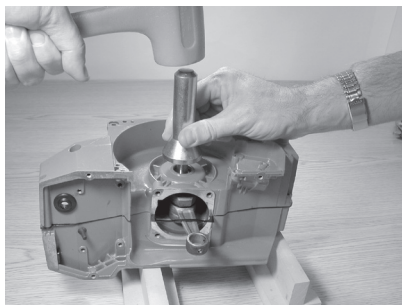

## 20.21

Install main crankcase bolts.

A. Use Loctite® 242.

B. Torque to 69 in.-lbs. (7.8 Nm.)

NOTE: The (3) remaining crankcase bolts will be installed during the completion of the assembly.

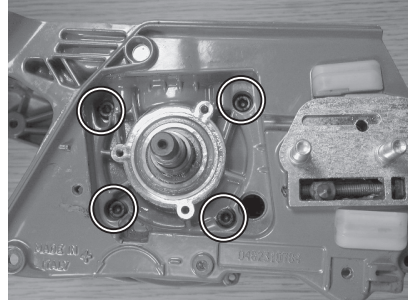

## 20.22

Install flywheel side crankcase seal — tap with bearing driver and mallet.

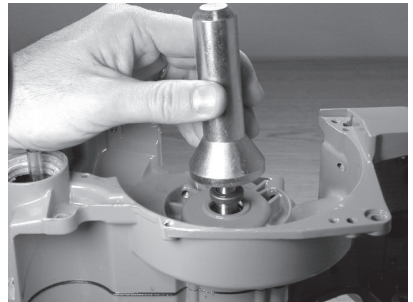

## 20.23

Trim crankcase gasket flush.

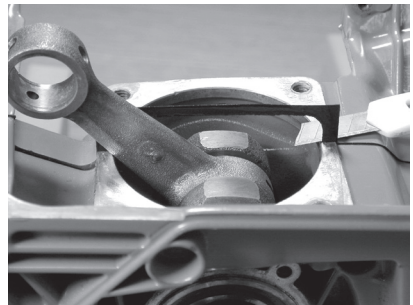

**21. This section covers the removal and installation of the bar studs and bar pad.**

21.1

Remove bar studs.

- A. Remove side cover.
- B. Install side cover nuts, flange to flange and tighten together.
- C. Attempt to remove the inside nut which should pull out the bar stud.
- D. Repeat on the second bar stud.

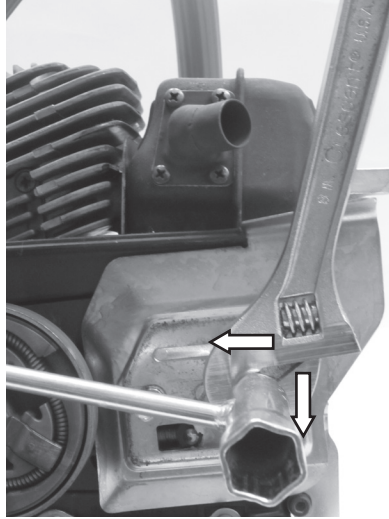

21.2

Remove bar pad.

- A. Remove sealing o-ring.

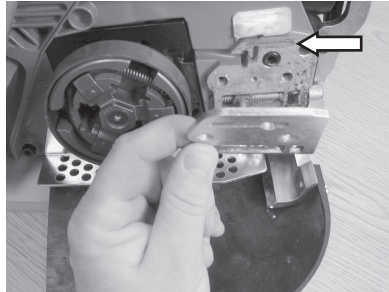

21.3

Assemble in reverse order.

**22. This section covers the removal and installation of the chain tensioner.**

## 22.1

Remove bar plate to expose the chain tensioner.

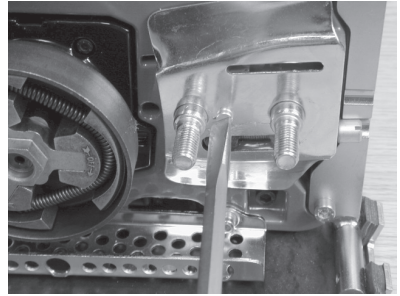

## 22.2

Unscrew tensioner to remove.

- A. Remove tensioner pin.
- B. Remove tensioner screw keeper.

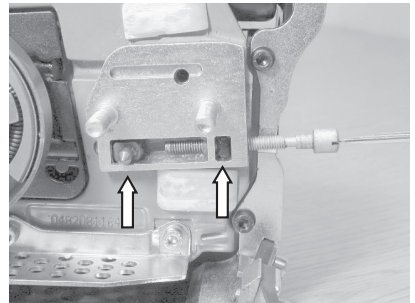

## 22.3

Assemble in reverse order.

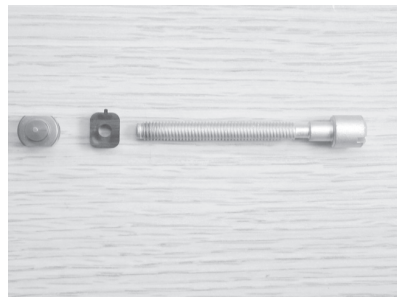

**23. This section covers carburetor tuning. Included in this section are basic settings, idle speed adjustment, and complete adjustment.**

The carburetor has been set at the factory for optimal performance and compliance to EPA Phase II emissions standards. However, minor adjustments may be required in certain conditions, such as high elevation.

**NOTES:**

- These power cutters are equipped with an electronic speed limiter, as part of the ignition system. This will prevent the power cutter from going above 12,000 RPM. Attempting to set the carburetor mixture to increase the speed or power beyond this limit may seriously damage the engine.
- Always check the air filter, pre filter, fuel filter, and spark plug before making carburetor tunings and clean or replace if necessary.

23.1

Basic Setting:

H = 2 1/4 - 2 3/8 turns from closed.

L = 1 1/4 to 1 3/8 turns from closed.

Complete carburetor readjustment.

RPM settings for power cutters.

**NOTE:** Power Cutters tuned without chain installed.

Idle Speed = 3,000 ± 200 rpm

Full Throttle = 11,500 ± 500 rpm

23.2

Remove limiter cap.

A. Limiter caps can only be removed after the cylinder cover and screw boot have been removed. Observe orientation of the release slots on the adjustment screw limiter cap. See section 10 for cylinder cover removal.

B. Insert the limiter cap puller into the center of the limiter cap.

C. Firmly hold the tool shaft while screwing in the puller screw until the screw head is against the puller shaft.

D. Unscrew the puller screw, 1/4 turn and pull straight out. Repeat for second limiter cap.

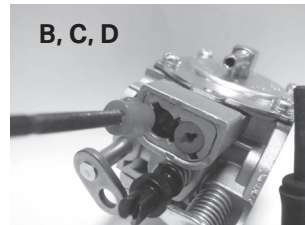
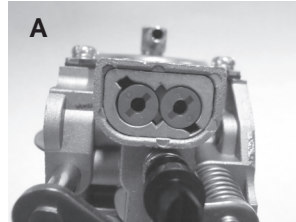

23.3

Using a 5/64" straight blade screwdriver, gently turn the adjustment screws clockwise until completely closed.

23.4

Set the adjustment screws at the basic setting (see section 23.1).

**⚠** The side cover must be held tightly in place with the side cover nuts, using a bar and no chain. **Failure to follow this procedure may result in personal injury and or damage to the power cutter.**

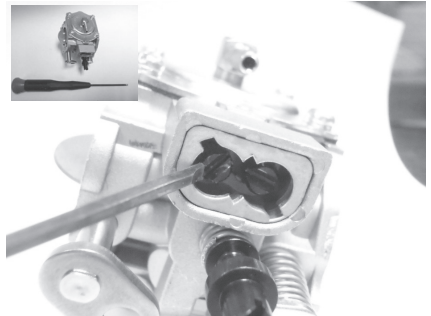

23.5

Start the power cutter and warm up the engine.

23.6

With a tachometer check the power cutter rpm, with a bar and no chain.

Idle =  $3,000 \pm 200$  rpm.

If the idle rpm does not fall into this range, adjust the T screw, clockwise to raise rpm, counterclockwise to lower rpm.

23.7

With a tachometer check the power cutter full throttle rpm, with no bar and chain:

Target:=  $11,500 \pm 500$  rpm

23.8

If the full throttle falls below this range, turn the H screw in (clockwise) 1/16th of a turn at a time.

A. Pulse the throttle to help stabilize the system.

 Do not hold the power cutter at max rpm for more than 5 seconds or cylinder damage could occur.

23.9

When the carburetor is adjusted correctly, set the limiter caps securely onto the needle screws with a straight blade screwdriver.

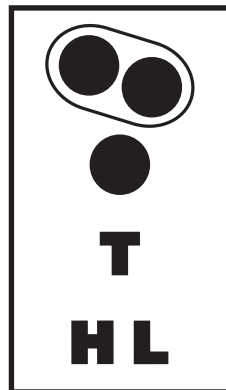



**24. This section covers idle speed adjustment.**

## 24.1

If engine stops while idling:

- A. Make sure the chain is properly tensioned.
- B. Turn T screw clockwise until chain begins to move.
- C. Back T screw out 1/2 turn.

## 24.2

If chain turns at idle.

Back T screw out until chain stops moving.

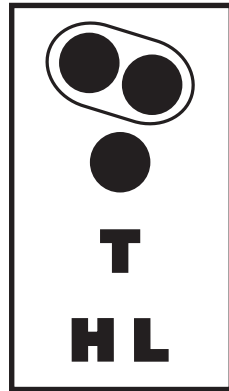

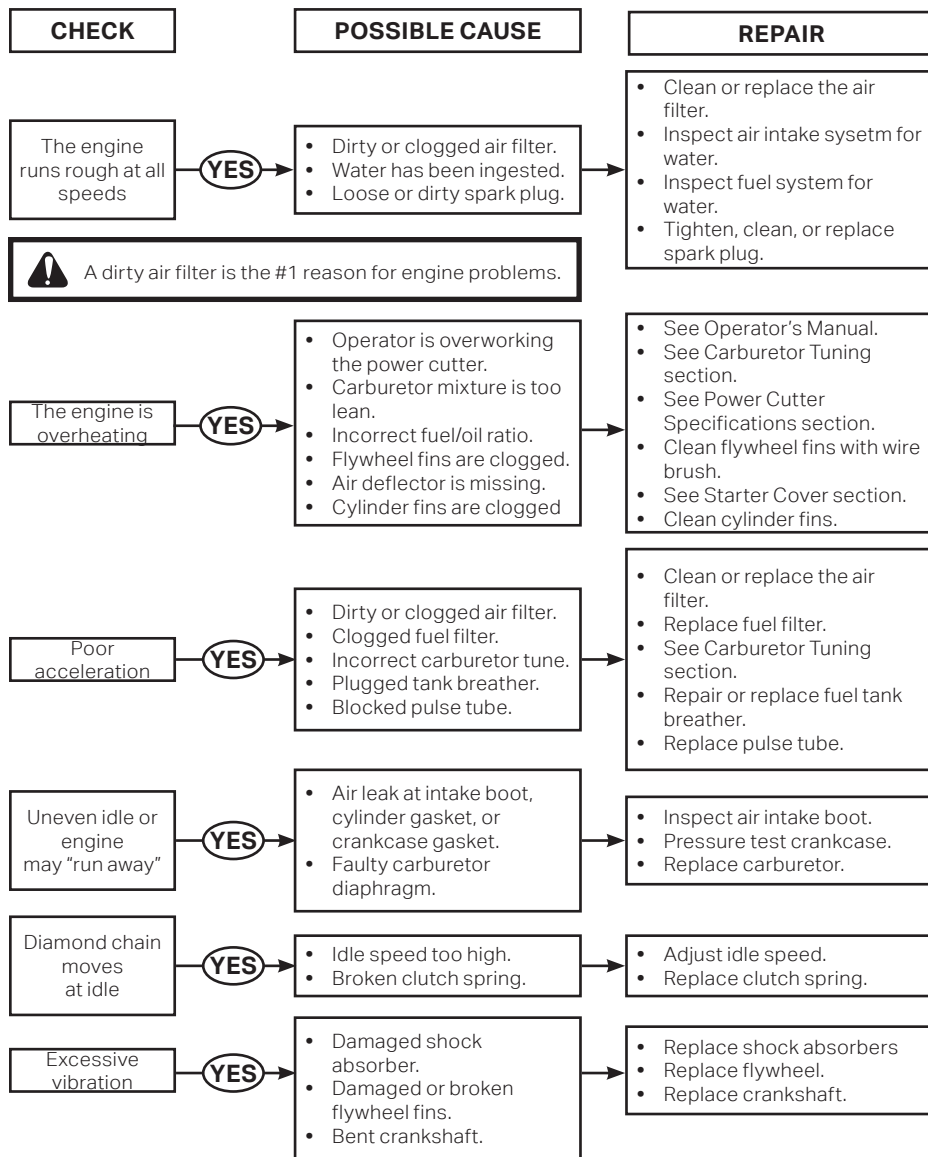

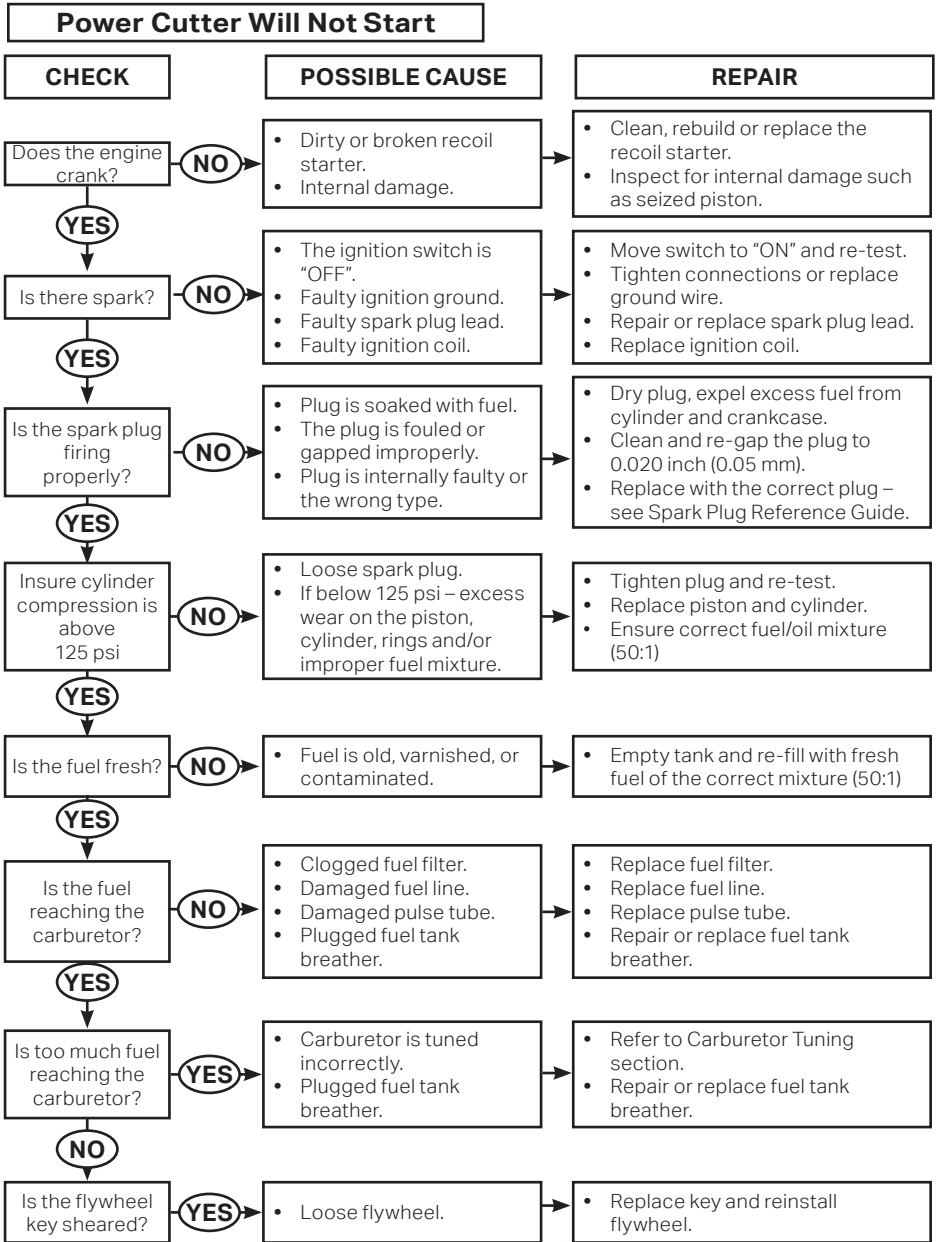

**26. This section covers testing the fuel system for leaks. Engine starvation can result from a leak or malfunction of any of the main components of the fuel system. The five main components are the fuel tank, fuel tank breather, fuel filter, delivery tubes, and carburetor.**

## 26.1

Remove and inspect the fuel filter.

A. Replace the fuel filter if there is any foreign material in the felt or the internal screen.

## 26.2

Test the main fuel pick-up tube for leaks.

A. Install the pressure gauge and bulb.

B. Pressurize the tube to 7psi (0.5 bar).

C. If the pressure does not maintain, separate the fuel line from the carburetor.

D. Plug one end of the main fuel pick-up tube.

E. Re-pressurize the tube to 7psi (0.5 bar).

F. Replace the tube if pressure is not maintained.

G. If the main fuel pick-up tube does maintain pressure, then the leak has been isolated to the carburetor. Refer to the Walbro Diaphragm Carburetor Service Manual.

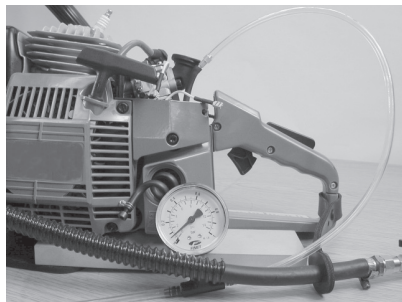
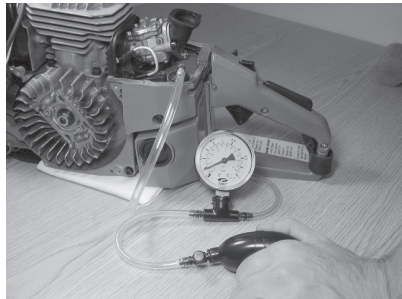

## 26.3

The fuel tank breather stabilizes the pressure in the fuel tank preventing both excessive pressure, which could flood the engine, and negative pressure, which could starve the engine of fuel.

## 26.4

Fuel tank breather is located inside the air filter compartment.

## 26.5

Testing the fuel tank breather.

- A. Attached the pressure gauge and bulb to the main fuel pick-up tube at the carburetor. Pressurize the tube to 4.5 psi (0.3 bar).
- B. The pressure should reduce to nearly 0 psi (0 bar) over about 3 seconds.

## 26.6

If the pressure does not reduce to 0 psi, disassemble or replace the breather.

- A. Clean the parts with solvent or fuel.
- B. Assemble in reverse order.
- C. Make sure that the spring taper is oriented in the correct direction. Narrow end towards the end of the cap.

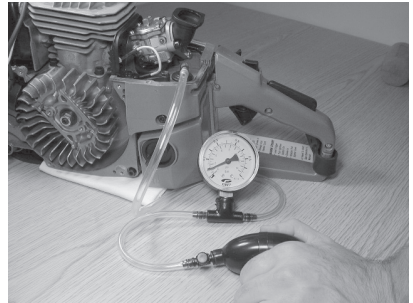
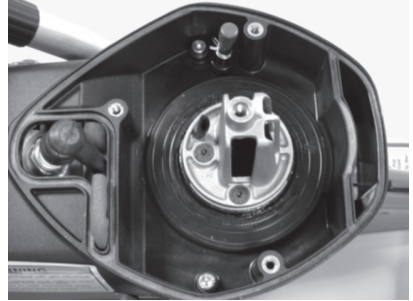

## 27.1

Install the intake seal flange.

A. Plug cylinder pulse tube.

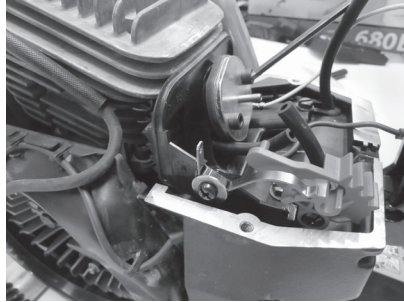

## 27.2

Install the exhaust seal flange.

## 27.3

Block one of the flange tubes with a rubber plug.

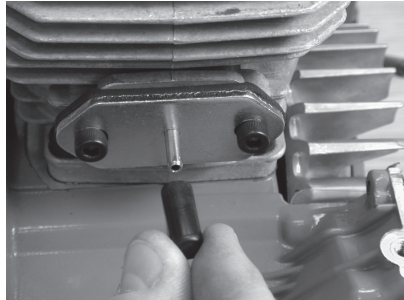

## 27.4

Install the pressure gauge and bulb.

## 27.5

Pressurize the crankcase to 7psi (0.5 bar).

## 27.6

If the pressure does not remain the same, use soapy water to find the leak.

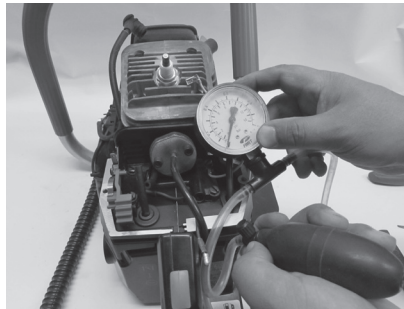

NOTE: It is recommended that this test be performed after an engine rebuild.

Spark Plug Reference Guide		
ICS Part Number	Champion	NGK
514770	RCYJ4	BPMR8Y

# 680ES SERVICE MANUAL

**ICS, Oregon Tool, Inc.  
4909 SE International Way  
Portland, OR 97222, USA  
Tel 800.321.1240**

**ICS, Oregon Tool Europe S.A.  
Rue Emile Francqui, 5  
1435 Mont-Saint-Guibert, Belgium  
Tel +32 10 301 251**

**[icsdiamondtools.com](http://icsdiamondtools.com)**